

THUNDER LASER SYSTEMS



NOVA Series Unified User's Manual

For NOVA 24, 35, 51, and 63

Thunder Laser

www.thunderlaser.com

tech@thunderlaser.com

January 2024

DONGGUAN THUNDER LASER EQUIPMENT CO.,LTD

Dongguan City, Guangdong Province, China

Introduction

This manual has been designated as the thunder laser systems, laser cutting machine installation and user guide; The manual is divided into five chapters, including general information instructions, safety instructions, the key components of every laser cutting systems and the installation steps, operation instructions and maintenance instructions from THUNDERLASER Company.

First, it should be emphasized that the installation of each system must meet the requirements, and make it consistent with the installation requirements of THUNDERLASER. If not, the machine will not working properly, poor performance, life shortened, maintenance costs increased and even machine damage .

The note is for getting a specific requirement of system installation, and we hope every customer try to understand these notes before installation and usage, thus you can correctly install and use. If you meet any installation problems, you can contact our technical staff and customer service staff.

At the same time, you can also refer to the machine installation video that we posted on YouTube. The specific URL is:

[How to setup your Nova laser cutter 2020 - YouTube](#)

Or

<https://www.youtube.com/watch?v=NpLo1L0NQx8&list=PLjSZrgjcrhs7QucNN-3jx7rZapDGfjG-5>

Contents

CHAPTER 1. GENERAL 5

1.1 GENERAL INFORMATION5

1.2 DESIGNATED 6

1.3 DISPOSAL REMARKS6

1.4 TECHNICAL DATA / DEVICE SPECIFICATION7

1.5 EC DECLARATION OF CONFORMITY 9

1.6 ROHS CERTIFICATE 10

1.7 MANUFACTURER'S LABEL 11

CHAPTER 2. SAFETY 12

2.1 GENERAL SAFETY INFORMATION12

2.2 LASER SAFETY INFORMATION 13

2.3 SAFETY PRECAUTIONS WHEN OPERATING THE DEVICE 13

2.4 WARNING AND INFORMATION LABELS 14

CHAPTER 3. PROCESS OF INSTALLING 16

3.1 UNPACKING 16

3.2 LOCATION 17

3.3 BEFORE INSTALLATION 18

3.4 EXHAUST SYSTEM – REQUIREMENTS 20

3.5 AIR SYSTEM – REQUIREMENTS 20

3.6 WATER COOLING SYSTEM – REQUIREMENTS 21

3.7 COMPUTER – REQUIREMENTS 22

3.8 CONNECTIONS 23

3.8.1 *Connecting the Mains* 23

3.8.2 *Connecting the Computer* 24

3.8.3 *Connecting the Air System* 25

3.8.4 *Connecting the Exhaust System* 26

3.8.5 *Connecting the Cooling System* 28

CHAPTER 4. OPERATION 30

4.1 MACHINE VIEW 30

4.2 ON/OFF SWITCH 35

4.3 HOW TO SETUP THE OEM SOFTWARE 36

4.3.1 *Software installation* 36

4.3.2 *Make connection between PC and machine* 38

4.4 HOW TO USE THE DISPLAY 41

4.4.1 *Function of the Buttons* 41

4.4.2 *The main interface* 43

4.4.3 *Speed button* 44

4.4.4 *Max Power buttons* 44

4.4.5 *Set the Layer Parameters* 44

4.4.6 *Menu button* 45

4.4.7 *File button* 45

4.5 HOW TO USE THE DIFFERENT NOZZLES LASER HEAD CONE 48

| | | |
|-------------------|--|-----------|
| 4.6 | HOW TO REPLACE THE 4 INCH AND HR LASER HEAD | 49 |
| 4.7 | HOW TO ADJUST FOCUS DISTANCE BY MANUAL OR AUTO | 50 |
| 4.8 | HOW TO USE THE TL-TIMER | 54 |
| 4.9 | HOW TO USE AIR-ASSIST CONTROL (IF EQUIPPED) | 56 |
| 4.10 | HOW THE HEAT ALARM SYSTEM WORKS | 58 |
| 4.11 | THE FIRST TIME RUNNING THE LASER | 59 |
| 4.12 | WORKSTATION AREA INDICATION | 62 |
| 4.13 | HOW TO USE THE CHUCK ROTARY AXIS ATTACHMENT | 63 |
| 4.14 | FOR LASER ENGRAVING | 65 |
| CHAPTER 5. | MAINTENANCE | 66 |
| 5.1 | CLEANING THE LASER MACHINE | 66 |
| 5.2 | CLEANING THE OPTICAL PARTS | 67 |
| 5.2.1 | <i>Cleaning the Focus Lens</i> | 67 |
| 5.2.2 | <i>Cleaning the Mirrors</i> | 69 |
| 5.2.3 | <i>Cleaning Laser Combiner</i> | 71 |
| 5.3 | MAINTAIN THE X/Y/Z RAILS | 72 |
| 5.4 | CHECK THE BEAM PATH | 73 |
| 5.5 | CHANGE COOLING WATER FOR THE WATER CHILLER | 73 |
| 5.6 | MAINTENANCE PLAN | 74 |

Chapter 1. General

1.1 General Information

Please read this documentation carefully before installation and operation.

Injury, death, loss of property, fire, electric shock, malfunction, reduced performance & machine life, and critical failures can result from not reading, understanding, and following the Operation Manual!

Operation of the system is permitted only with equipment and spare parts supplied or listed in the spare parts and consumables lists. The use of 3rd Party components may void the warranty.

Auxiliary equipment must be adjusted to the base machine (contact us for further info).

The following symbols are used throughout the Operation Manual:



Caution: Warnings to keep in mind when operating the laser.

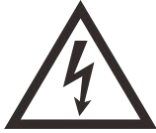

High Voltage: Care must be taken to prevent injury and/or death.

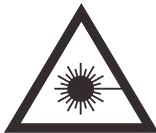

Laser Radiation: Pay attention to the dangers of the laser beam.



Fire Hazard: High potential for fire. NEVER RUN UNATTENDED!



Tips: Helpful notes or info that simplify the use or understanding.

1.2 Designated

The THUNDER LASER NOVA SERIES is used for engraving and cutting of signs, stamps and suchlike.

A wide variety of materials such as rubber, acrylic, coated metal, tin, special steel, anodized aluminum, cork, cardboard, glass, leather, marble, several plastics and wood can be processed on the laser.



1. The engraving process must only be performed with a perfectly adjusted machine.
2. For cutting applications with 80 W the use of the cutting table is absolutely necessary.
3. Use of the system in other areas is against the designated use. The manufacturer does not admit liability for damage to personal and/or equipment resulting from such use.
4. The system must only be operated, maintained and repaired, by personnel that are familiar with the designated field of use and the dangers of the machine!
5. Non-observance of the instructions for operation, maintenance and repair described in this Operation Manual excludes any liability of the manufacturer if a defect occurs.
6. Caution when processing conductive materials (carbon fibers), Conductive dust or particles in the ambient air might damage electrical components and lead to short circuits. Bear in mind that those defects are not warranted.

1.3 Disposal remarks



Do not dispose the machine with domestic waste!

Electronic devices have to be disposed according to the regional directives on electronic and electric waste disposal. In case of further questions, please ask your supplier. He might take care of proper disposal.

1.4 Technical Data / Device Specification

Mechanics

| | NOVA 24 | NOVA 35 | NOVA 51 | NOVA 63 |
|-------------------------|---------------------------------------|--------------------------------|---------------------------------|----------------------------------|
| Working Area | 23.6"x 15.7" (600 x 400 mm) | 35.4"x 23.6" (900 x 600 mm) | 51.2"x 35.4" (1300 x 900 mm) | 63.0"x 39.4" (1600 x 1000 mm) |
| Table Size | 27.6"x 20.9" (700 x 530mm) | 39.4"x 28.7" (1000 x 730mm) | 55.1"x 40.6" (1400 x 1030mm) | 66.9"x 44.5" (1700 x 1130mm) |
| Z Axis Height | 6.1" / 155 mm | 8.9" / 225 mm | | |
| Max Work Height | 6.1" / 155 mm | 8.9" / 225 mm | | |
| Max. Speed | 39"/sec. (1000 mm/sec) | | | |
| Motor | Easy Servo Motor | | | |
| Drive | Hybrid Servo Drive | | | |
| Work piece table | Solid metal blades & Honey comb table | | | |
| Max. table load | 20kg / 44lbs | 40kg / 88lbs. | 30kg / 66lbs | 30 kg / 66lbs |
| Net Weight | 140kgs / 308lbs | 310kgs / 682lbs | 430kgs / 946lbs | 470kgs / 1,034lbs |
| Standard Head | 2.0" (50.8mm) | | | |
| Lens Diameter | 20mm | | | |
| Mirror Diameter | 25mm | | | |
| Beam Comb. Dia. | 20mm | 25mm | | |

Dimensions

| | NOVA 24 | NOVA 35 | NOVA 51 | NOVA 63 |
|------------------|---|---|---|---|
| W x D x H | 42.1" x 31.9" x 24" (1070x810x610mm) | 59.1" x 43.5" x 40.9" (1500x1105x1040mm) | 74.8" x 55.3" x 40.9" (1900x1405x1040mm) | 86.6" x 59.3" x 40.9" (2200x1505x1040mm) |

Max Part Size (W x L x H)

| | NOVA 24 | NOVA 35 | NOVA 51 | NOVA 63 |
|--------------------|---|---|--|--|
| Door Closed | 27.6"x 20.9"x 8.3" (700 x 530 x 155mm) | 39.4"x 28.7"x 8.9 " (1000 x 730 x 225mm) | 55.1"x 40.6"x 8.9 " (1400 x 1030 x 225mm) | 66.9"x 44.5"x 8.9 " (1700 x 1130 x 225mm) |
| Pass Thru | 27.6" x ∞" x 1.2" (700 x ∞mm x 20 mm) | 39.4" x ∞" x 1.2" (1000 x ∞mm x 20 mm) | 55.1" x ∞" x 1.2" (1400 x ∞mm x 20 mm) | 66.9" x ∞" x 1.2" (1700 x ∞mm x 20 mm) |

Features

Standard:

Open flap protection, "No Water "protection, Fire alarm protection, Dual air-assist control, Red Dot Pointer, Auto Focus, Smart board, Motorized Table, Honey Comb Table, Aluminum blade cutting table, Pass-Through Door, 2,0"(50.8mm) Focus Lens, Warning light, Emergency Stop, LCD Display, Easily Adjustable Home Position, 3D Engraving, Maintenance mode, Air pump, Water chiller, Exhaust Fan.

Optional:

Rotary Attachment, High Resolution head (up to 1000DPI, while standard laser head Max is 500DPI), High air compressor set (Includes water filter).

Control System

| | |
|--------------------|--|
| Laser power | Adjustable from 1 - 100% (typically 5-100%) |
| Interface Hardware | USB: connect to PC and U-disk Ethernet: connect to PC |
| Interface Software | LightBurn - RDWorksV8 |
| Operating Modes | Optimized raster, vector, and combined mode |
| Buffer Memory | 128 MB standard |

Laser Equipment

| | |
|--------------------------------|-----------------------------|
| Laser Type: | Sealed CO2 Glass Laser Tube |
| Standard Laser Power: | 40W, 60W, 80W, 100W, 130W |
| Wavelength: | 10.6µm |
| Red dot pointer: | Laser Power< 1mW |
| Wavelength of Red dot pointer: | 630nm – 680nm |

Cooling System

| | |
|-------------------------|--------------|
| Machine Cooling System: | Air-Cooled |
| Tube Cooling System: | Water Cooled |

Electricity, Power, Breaker INCLUDING THE CHILLER

| | 40 WATT | 60 WATT | 80 WATT | 100 WATT | 130 WATT |
|-----------------------------|--|----------------------|----------------------|----------------------|----------------------|
| Electricity Requirement | 110 or 220 Volt AC,50 or 60Hz,Single phase Machine requires either 110V or 220V voltage(customized from factory); Support both 50Hz and 60Hz, single phase | | | | |
| Power consumption | 1600W | 1700W | 1900W | 2000W | 2200W |
| Recommended circuit breaker | 15A,110V 10A,220V | 15A,110V 10A,220V | 20A,110V 10A,220V | 20A,110V 10A,220V | 25A,110V 15A,220V |

Ambient Conditions

| | |
|---------------------|---------------------------------|
| Ambient temperature | +15°C to +35°C / 59°F to 95°F |
| Humidity | 40% to max. 70%, not condensing |

Laser Safety

| | |
|-------------|---|
| Laser class | CDRH Laser Safety Laser Class 2 CE compliant FDA approved |
|-------------|---|

1.5 EC Declaration of Conformity

EC Declaration of Conformity

We

Dongguan Thunder Laser Equipment Co., Ltd.

Company's address

Mintian, Shatian Dadao, Shatian Town, Dongguan, Guangdong, China

declares that the product described is in conformity with

The Machinery Directive: 2006/42/EC and The EMC Directive: 2004/108/EC

Applicable Harmonized standards:

EN ISO 11553-1:2008

EN 60204-1:2006+A1:2009

EN ISO 12100:2010

EN 60825-1:2014

EN ISO 13849-1:2008/AC:2009

EN ISO 13849-2:2012

Product Name

Laser System

Product Model

NOVA 24, NOVA 35, NOVA 51, NOVA 63, MINI 60, ODIN 22, ODIN 32

Trade Mark



Name and address of the person authorized to compile the technical file

Name: Tom Tang, Address: Banalog Farm, Banalog Terrace Hollybush Caerphilly, UK, NP12 0SF

Authorized Representative:

We guarantee that we will provide the authorized representative information before we export the machine to E.U.

Responsible for making this declaration is the

Manufacturer

Authorized representative established within the EU

2020-07-04

Mintian, Shatian Dadao,
Shatian Town,
Dongguan, Guangdong,
China

Issue date and Place

Tom Tang

General Manager

Name and position



Signature and company stamp

1.6 RoHS Certificate

CERTIFICATE

ATTESTATION CERTIFICATE OF RoHS COMPLIANCE DIRECTIVE 2011/65/EU

Technical File of the company mentioned below has been inspected and assessment has been completed successfully

2011/65/EU RoHS Compliance of Directive have been taken as references for these processes

Company Name : Dongguan Thunderlaser Industrial Co., Ltd.

Company Address : 109, Building 2, 159 Shatian Avenue, Shatian Town, Dongguan city, Guangdong Province, China, 523980

Related Directives and Annex : Directive 2011/65/EU Restriction of the Use of Certain Hazardous Substances in Electrical and Electronic Equipment

Related Standards : EN 50581:2012

Product Name : Laser cutter

Report No and Date : ZTL-2022011701R

Product Brand/Model/Type : Thunderlaser// Nova35 Nova24, Nova35, Nova51, Nova63, Mini60



Certificate Number : M.2021.206.C70945
Initial Assessment Date : 21.01.2022
Registration Date : 24.01.2022
Reissue Date/No : -
Expiry Date : 23.01.2027

UDEM International Certification
Auditing Training Centre Industry
and Trade Inc.Co

The validity of the certificate can be checked through www.udemita.com.tr. The CE Mark shown on the right can only be used under the responsibility of the manufacturer with the completion of EC Declaration of Conformity for all relevant directives. Other relevant directives for CE Marking directives have not been considered during RoHS assessment even they may apply. The result relates only to the item(s) tested and no amounts above the limites have been detected. This certificate remains as the property of UDEM International Certification Auditing Training Centre Industry and Trade Co., Ltd. whom it must be returned upon request. The above names firm must keep a copy of this certificate for 15 years from the registration of certificate. This certificate only covers the product(s) stated above and UDEM must be noticed in case of any change(s) on the product.

Address: Mutfukent Mahallesi 2073 Sokak (Eski 93 Sokak) No:10 Çankaya – Ankara – TURKEY

Phone: +90 0312 443 03 90 Fax: +90 0312 443 03 76

E-mail: info@udemita.com.tr www.udemita.com.tr



1.7 Manufacturer's Label

The manufacturer's label is located on the back of the device (see Figure below).

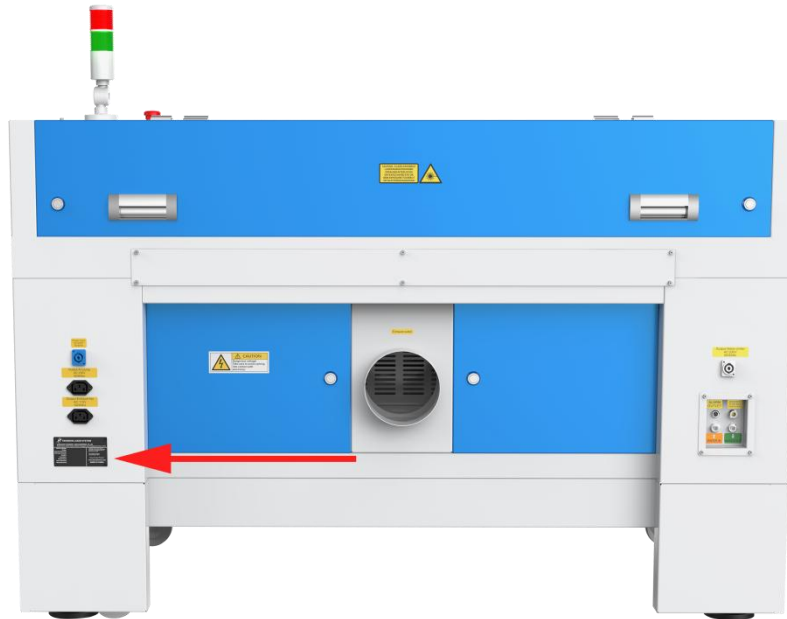

It is recommended to record all of the data so that you always have this handy. You will need to supply your Serial Number to our Support Team on occasion.



Chapter 2. Safety

2.1 General Safety Information

All personnel involved in installation, set-up, operation maintenance and repair of the machine, must have read and understood the Operation Manual and in particular the "Safety" section. The user is recommended to generate company-internal instructions considering the professional qualifications of the personnel employed in each case, and the receipt of the instruction/Operation Manual or the participation at introduction/training should be acknowledged in writing in each case.

Safety-conscious of Working

The machine must only be operated by trained and authorized personnel.

The scopes of competence for the different activities in the scope of operating the machine must be clearly defined and observed, so that under the aspect of safety no unclear questions of competence occur. This applies in particular to activities on the electric equipment, which must only be performed by special experts.

For all activities concerning installation, set-up, start-up, operation, modifications of conditions and methods of operation, maintenance, inspection and repair, the switch-off procedures that may be provided in the Operation Manual must be observed.

Safety Information for the User and/or Operating Personnel



1. No working methods are permitted that affect the safety of the machine.
2. The operator must also ensure that no unauthorized persons work with the machine (e.g. by activating equipment without authorization).
3. It is the duty of the operator, to check the machine before start of work for externally visible damage and defects, and to immediately report changes that appear (including behavior during operation) that affect the safety.
4. The user must provide that the machine is only operated in perfect condition.
5. The user must guarantee the cleanness and accessibility at and around the machine by corresponding instructions and controls.
6. No safety components may be removed or disabled (again we emphasize the imminent dangers, for example severe burns, loss of eyesight, etc...). If the removal of safety components is required during repair and service, the replacement of the safety components must be performed immediately after completion of the service and repair activities.
7. Preparation, retooling, change of work piece, maintenance and repair activities **must only performed with equipment switched off** and by trained personnel.
8. **Any attempt to perform unauthorized modifications and changes to the machine can VOID THE WARRANTY.** This does not apply to preventative & general maintenance, adjustment and alignment, etc... that follow Thunder Laser's best practices.

2.2 Laser Safety Information



1. To assess the potential dangers laser systems pose, they are classified into 2 safety classes, Thunder Laser NOVA series is a device of class 2. This is guaranteed by the protective housing and the safety installations.

Please note that improper and warranty operation of the device can override the status of Safety class 2 and can cause the emission of harmful radiation.

2. This laser engraving system contains a carbon dioxide (CO₂) laser of class 4 that emits intensive and invisible laser radiation. Without safety precautions the direct radiation or even diffuse reflected radiation is dangerous!

3. Without safety precautions, the following risks exist with exposure to laser radiation:

Eyes: Burns to the cornea

Skin: Burns

Clothing: Danger of fire

4. Never try to modify or disassemble the laser and do not try to start up a system that had been modified or disassembled!

5. Dangerous radiation exposure can result from the use of operation or adjustment equipment other than that described here, and if different operational methods are performed.

2.3 Safety Precautions when Operating the Device

Your Thunder Laser NOVA SERIES has an integrated safety system which immediately stops the job when the protection cover (Lid) is opened. An incomplete job will occur if the cover is opened during operation. Press the "PAUSE" button first if you want to interrupt an engraving process.

Please remember the following safety precautions when working with this device:



1. CO₂ Fire extinguishers should be placed near laser. Always keep a properly maintained and inspected fire extinguisher on hand.
2. Do not store any flammable materials in the inside of the device. Particularly leftovers of produced materials have to be removed to prevent fire hazard.
3. Please maintain free airflow around this system at all times. Do not cover the machine while in operation.
4. Stay with the laser. Do not leave the laser unattended when it is working, small scraps can ignite and without supervision can destroy the machine if not checked.
5. Use Air Assist. Always use the system's Air Assist feature when vector cutting.



1. These lasers emit invisible radiation; safety glasses should be worn when maintaining these machines for your protection.
2. Adjustment of the beam path must be performed only by specially trained personnel. An improper setting can lead to uncontrolled emission of the laser radiation.



1. Do not disable limit switches or safety features as this can invalidate warranties and cause damage to you and the machine.
2. Before processing materials the user must verify whether harmful materials can be generated and whether the filter equipment of the exhaust system is suitable for the harmful materials. We emphasize that it is the responsibility of the user, to consider the national and regional threshold values for dust, fogs and gases when selecting the filters and the exhaust system. (The values for the maximum workplace concentration must not be exceeded.)
3. PVC (polyvinyl chloride) must under no circumstances be processed with the laser.

2.4 Warning and Information Labels



The warning and information labels in various locations if the machine should always be read carefully and understood. If labels are lost or damaged, they must be replaced immediately.

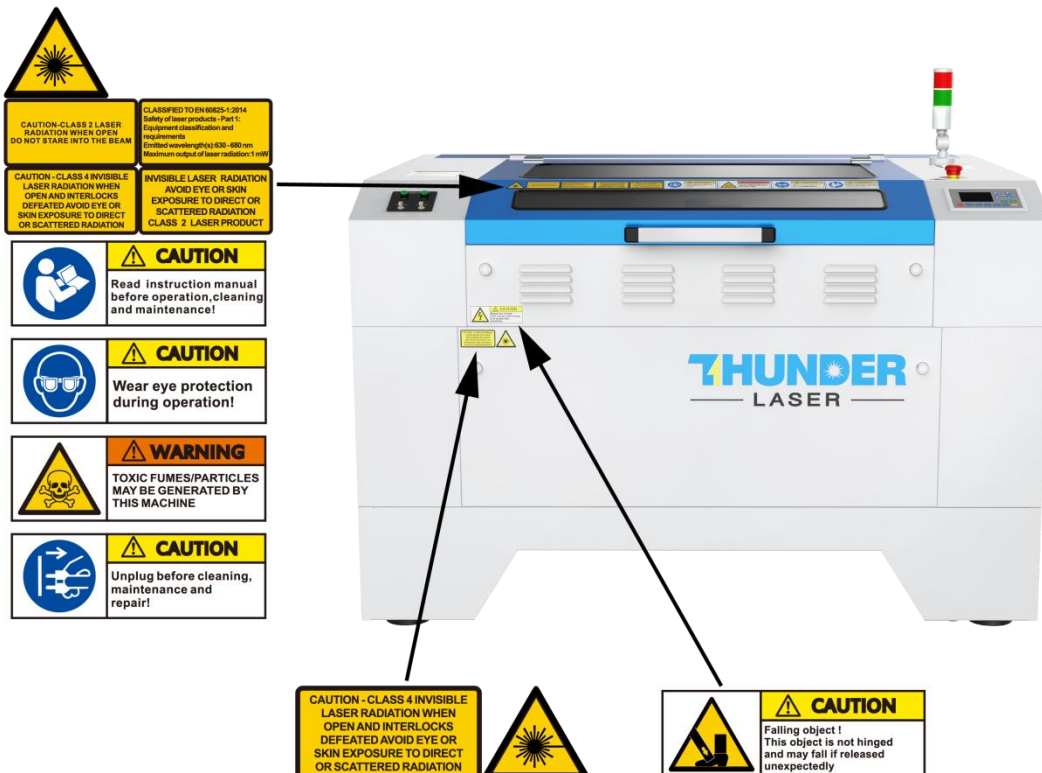

ATTENTION

1. The management & operator must read the operating manual carefully before operating this machine. Do not operate this machine without training.
2. Never under any circumstance run this machine if the water cooling is not circulating, damage will very rapidly occur to the laser tube if you do.
3. Never leave laser running unattended and always activate cut off switch when work is finished.
4. Pay close attention to the machine while it is running, and be prepared to pause the process and if necessary use the E-stop.
5. This machine contains multiple risks of invisible laser radiation (heat and high voltage), in combination with water cooling, and must be electrically grounded. In the case of a fault, never try to disassemble the machine, contact service provider and turn off power.
6. Spraying, maintenance and repairs must be conducted by trained professionals.
7. Do not operate this laser machine with any of the covers open, or attempt to defeat any of the safety interlocks. Doing so can result in burns, and there is potential for permanent damage to your eyesight.
8. The environment conditions of your production facility are crucial to the machine's potential lifespan. Specifically avoid high humidity, airborne dust and fluctuating temperatures. Do not allow the machine to freeze.
9. The optimal environmental temperature for the water cooling system ranges between 59 and 86°F (15 and 30°C). Only use distilled water and replace it regularly up to four times a year to maintain purity. After adding fill in the water will dilute the laser tube seals and the pump inside the water chiller unit.
10. Antistatic mats be suitable to the water chiller when the room temperature close to 0°C (32°F).
11. Do not store any flammable materials on or near the laser. The laser uses invisible radiation (heat) to vaporize/burn/ablate materials. Fire is a known risk with CO₂ lasers.
12. Regular cleaning of reflective mirrors and the focusing lens is essential to prevent power loss.
13. Remove objects and waste material from the interior of the machine, and regularly check and clean the extraction system to prevent buildup of dust and dirt which can foul a fire.
14. Do not attempt to laser mark or cut reflective materials. This can result in reflected invisible laser radiation (heat) which will damage the machine.
15. Keep a serviced CO₂ fire extinguisher nearby the laser always. Dry power extinguishers will cause irreversible corrosion if used.
16. In the case of any uncontrolled event or failure of your system, always contact your service provider for remedial professional assistance. No work can resume in a timely & safe manner.

Thank you for your cooperation!



CAUTION - CLASS 4 INVISIBLE LASER RADIATION WHEN OPEN AND INTERLOCKS DEFEATED AVOID EYE OR SKIN EXPOSURE TO DIRECT OR SCATTERED RADIATION



ATTENTION

Function of the signal lamp

Red light:
If laser machine is running a job or user starts it without closing door or water protection, the signal lamp is a red light.
The red light indicates the dangerous situation and user must stay with the laser.

Green light:
If laser machine is not at work, the signal lamp is a green light.
The green light indicates the safety situation and the laser machine is ready for operation.

Temperature warning:
If temperature is higher than 55°C (131°F) on working table, the signal lamp will make buzzing sound. (Roughly 80dBA within 1m, 75dBA within 5m and 65dBA within 10m, the sound gets weaker as it travels.)



CAUTION

Dangerous voltage!
Take care to avoid coming into contact with electricity!

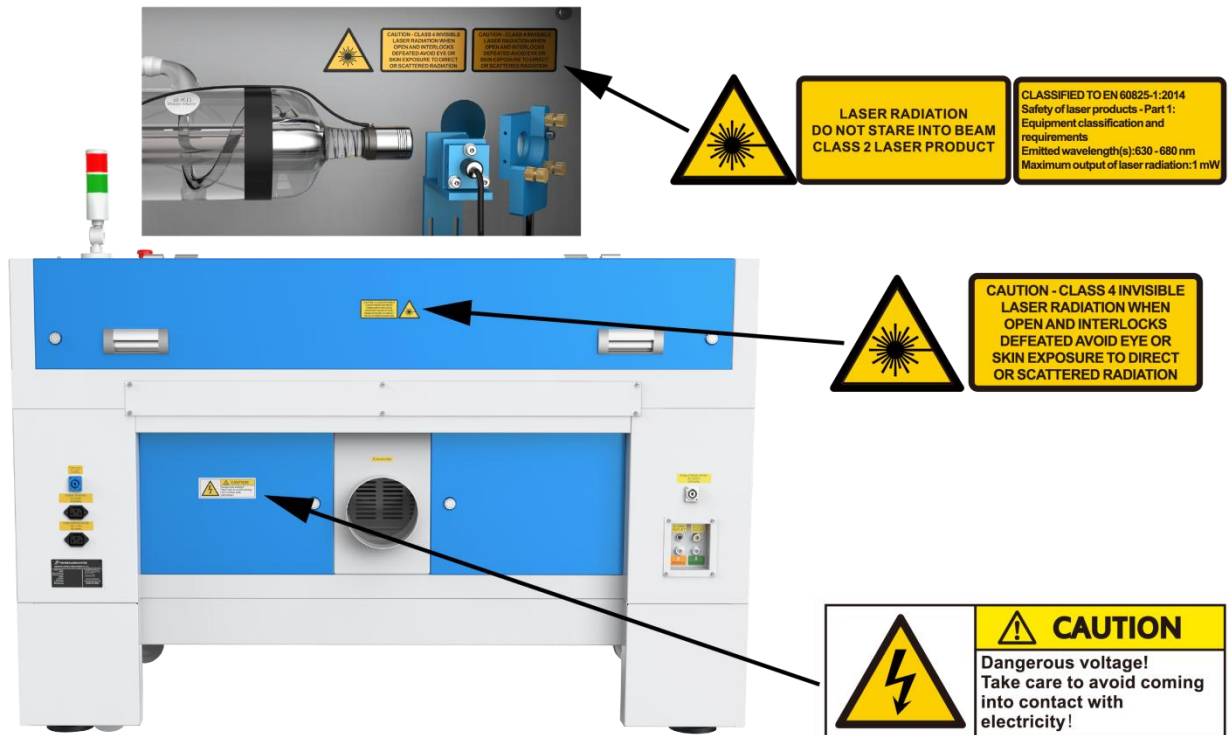

Chapter 3. Process of Installing

3.1 Unpacking

You receive your THUNDER LASER NOVA SERIES packed in a wooden box which contains the laser machine and additional accessories. The following steps give you an overview of the unpacking and assembly of the laser. Please follow these steps carefully.



Keep the packing box. You will require it in case of a return.

Dispose all waste according to the applicable waste disposal law.

1. Put the wooden box on a flat and spacious room for unpacking.
2. Remove the machine box; carefully remove the protective foam, wraps, films, etc...
3. Take out the key, open the door of the laser, remove the accessories box which contains all accessory parts required for the installation of the laser machine and check the contents carefully.

4. You will see an attachment table on the machine; please check whether the accessories are all on the table.
5. Please keep the keys and the warranty certificate as well as the model and serial number of the machine. If you need tech support we may ask you for this information.
6. Remove the sponges and nylon cable ties from inside the machine, and then start to install the machine, carefully following the instructions in this manual.

3.2 Location

Before you install the laser system, you should select an appropriate location. Follow the guidelines shown below:



1. Avoid locations where the system is exposed to high temperatures, dust and high humidity. (The humidity must not exceed 70% and the temperature must not be close to the dew point.)
2. Avoid locations, where the system is exposed to mechanical shocks.



1. Circuit Breaker protection: Do not connect other devices on the same circuit as the laser system. It requires a dedicated circuit.
2. DO NOT open any of the machine's access panels while the unit is plugged in. Opening a panel may expose the operator to severe electric shock, invisible CO2 laser radiation, mechanical pinch points, burns, blindness, and other hazards. **ALWAYS POWER OFF AND UNPLUG!**
3. DO NOT make or break any electrical connections to the system while the unit is turned on.



1. Avoid locations with poor air circulation; select a location close to ventilation (if available). Select a location, whose room temperature is between 15 °C and 25 °C (59° – 77° F).
2. This is fundamental to maintain consistent and reliable operation of a CO2 laser, Metal RF or Glass tube and the machine itself. Avoid higher ambient temperatures and strong exposure of the engraver to the sun. Use blinds, if required.
3. Mechanical shock and vibration of the laser will have detrimental effects on the performance and life expectancy of the machine. It will manifest (over a period of time) with a noticeable decrease in performance and increased maintenance required, possibly even damage. Setting your Thunder Laser up in a suitable temperature controlled, dust free, moisture free, level, stable surface (a level concrete floor) with the recommended extraction is critical to the ongoing performance of the machine. It is also a warranty condition.

3.3 Before Installation

1. Take out the sponge around the laser tube. Like below:

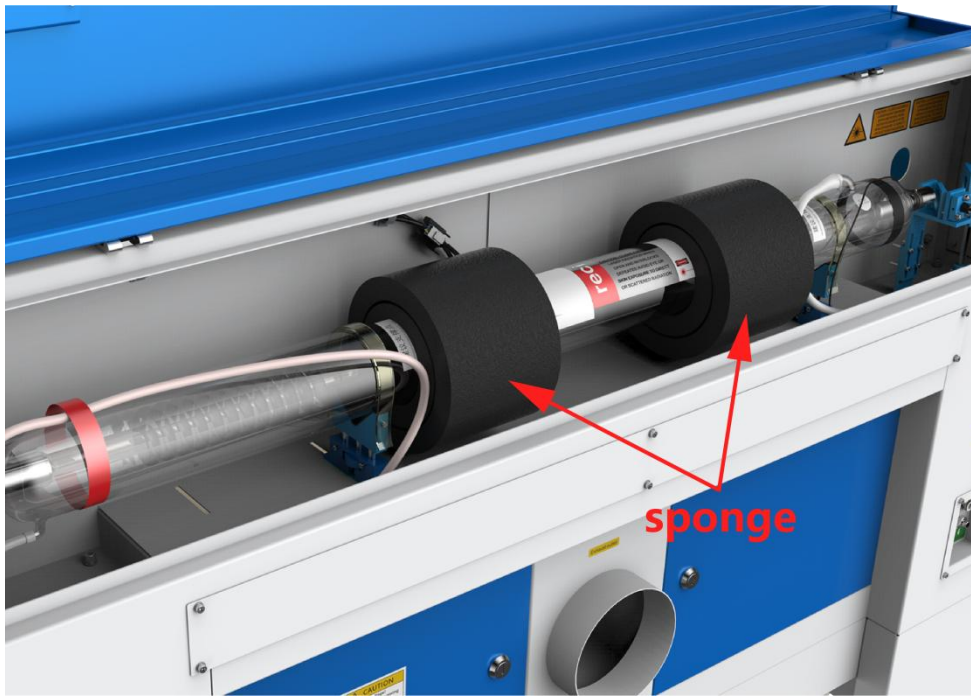

2. Remove the nylon cable ties around the honey comb plate.
Remove the transparent bag from the front of honey comb plate, Like below:



The transparent bag has a set of machine door keys, USB flash drive, and an engraving test sample. The USB flash drive stores software, manuals, libraries, etc... that you will need.

Reverse Offset/Scan Offset compensation settings for this specific machine are included. **These settings need to be entered into your RDWorks and/or LightBurn settings to ensure the highest engraving quality.** Refer to the Ruida and/or LightBurn Manuals for these necessary procedures.

3. **Rotate the E-Stop switch in the direction of the arrows to reset.** Familiarize yourself with the emergency stop button's operation and location.



4. **When you have the machine in its final position, please be sure to re-fix the feet in all four corners.**

Please see below:



The main power cable is in the tool box that came with the machine.

3.4 Exhaust System – Requirements

Proper fume extraction is imperative to evacuate the combustible and noxious fumes that are created during the lasing process. This machine must be equipped with an adequate exhaust system. This includes a blower of rated flow, volume, and duty cycle as well as properly installed ducting and peripherals. You can further reduce smells from fine particulate matter with an inline filtering system.



Connection - see section 3.8.4 connecting the Exhaust System.



Do not start the machine without an adequate exhaust system.

3.5 Air System – Requirements

The included air pump supplies the dual stage air assist control and is a critical component. This helps keep the focusing lens clean and cool during the engraving process. Air assist is also critical when cutting to reduce flame-ups and clear the debris field.



Always use the system's Air Assist feature when vector cutting.

3.6 Water Cooling System – Requirements

We supply genuine S&A CW-5000 series active water chillers to keep the laser tube cool. Overheating severely shortens tube life and causes irreparable damage to the tube. The supplied chiller only cools so it is of utmost importance to keep your laser from freezing!



Do not run the machine without an adequate water cooling system.

3.7 Computer – Requirements

The following recommendation represents the minimum requirements. When using a more powerful computer the graphics are generated and displayed faster and the computing times and the data transfer to the laser are reduced. To use the newest software version, you might have to abide other requirements.

- Windows 10 (32 bit or 64 bit)
- Windows 8 (32 bit or 64 bit)
- Windows 7 (32 bit or 64 bit)
 - Windows Vista (with Service Pack 1 or later)
 - Windows XP (with Service Pack 2 or later)
- 1024 MB of RAM, 400 MB of hard disk space
- Pentium® 3 or 4 processor or AMD Athlon™ XP
- 1024 x 768 or better monitor resolution
- 1 free USB interface
- 1 free Ethernet interface
- Mouse

These requirements are for RDWorks. LightBurn software renders jobs thousands of times faster than RDWorks. Check LightBurnSoftware.com for more information.

3.8 Connections



Perform the connections exactly in the order described; otherwise electrostatic charging can damage your computer and/or the electronics of the laser system.

3.8.1 Connecting the Mains

Connect one end of the mains cable with the connection socket at the rear side of the laser device (see Figure below) and the other end with a protected power outlet.

Mains voltage and operating voltage must correspond (AC 230V 50/60 Hz or AC 115V 50/60 Hz) – see information label beside the connection socket.



Under no circumstances should you switch on the device if the voltages do not correspond.

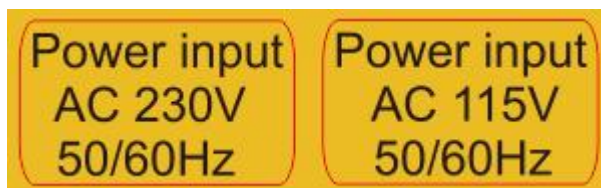

The mains cable is placed the front of the honey comb table.

3.8.2 Connecting the Computer

Connecting the Computer and the machine by using the USB cable. Like below:



Connecting the Computer and the machine by using the Ethernet cable. Like below:



The USB and Ethernet cable are placed inside the toolbox.

3.8.3 Connecting the Air System

First of all, install an air blowing mouth (copper) to the air system, then connect the hoses (white side) to the mouth, the other side to the machine. After that, please connect the power cable (of the air system) to the machine. Like below:

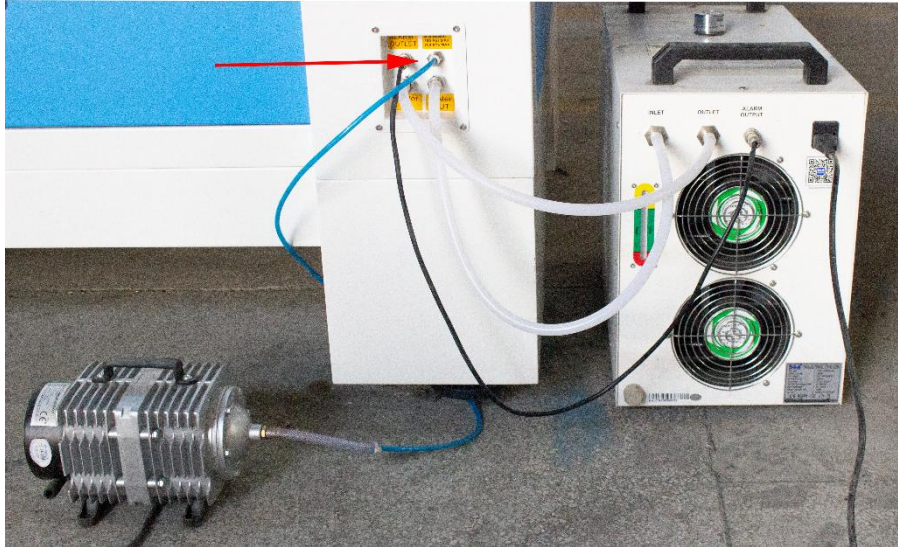

A customized anti-shock foam that came with the air pump can be placed under the air pump.

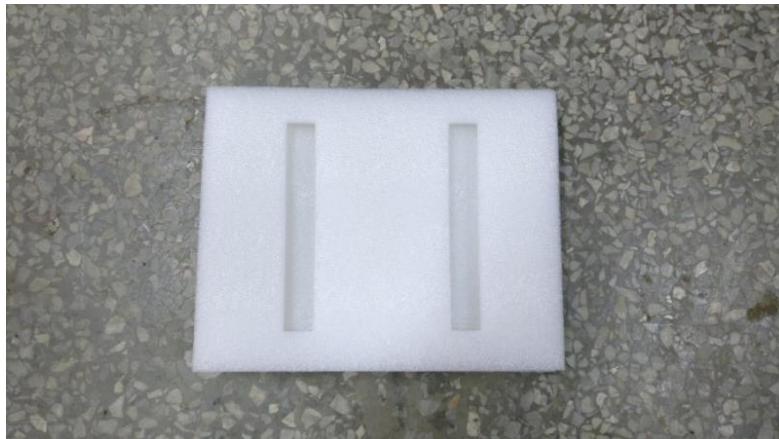

The input voltage must correspond (AC 230V 50/60 Hz or AC 115V 50/60 Hz) – see information label beside the connection socket.

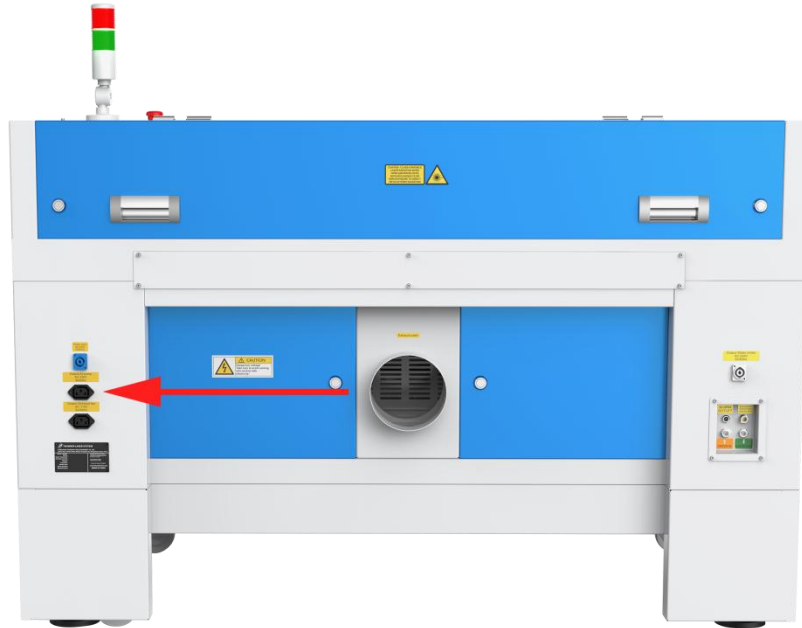

Output: Air compressor
AC 230V
50/60Hz

Output: Air compressor
AC 115V
50/60Hz

3.8.4 Connecting the Exhaust System

How to set up the exhaust system

Insert one side of the gray exhaust pipe into the fan inlet and the other side into the fuselage behind the exhaust tank. Insert one side of the gray exhaust pipe into the fan outlet and put the other side of the pipe outside where you work (If the machine is far from the outside of the room that the gas manufactured by the machine cannot be discharged; then you might need and dust/fume filter, it can keep the air quality of your working environment well). Please refer to the following pictures about how to install the exhaust pipe:

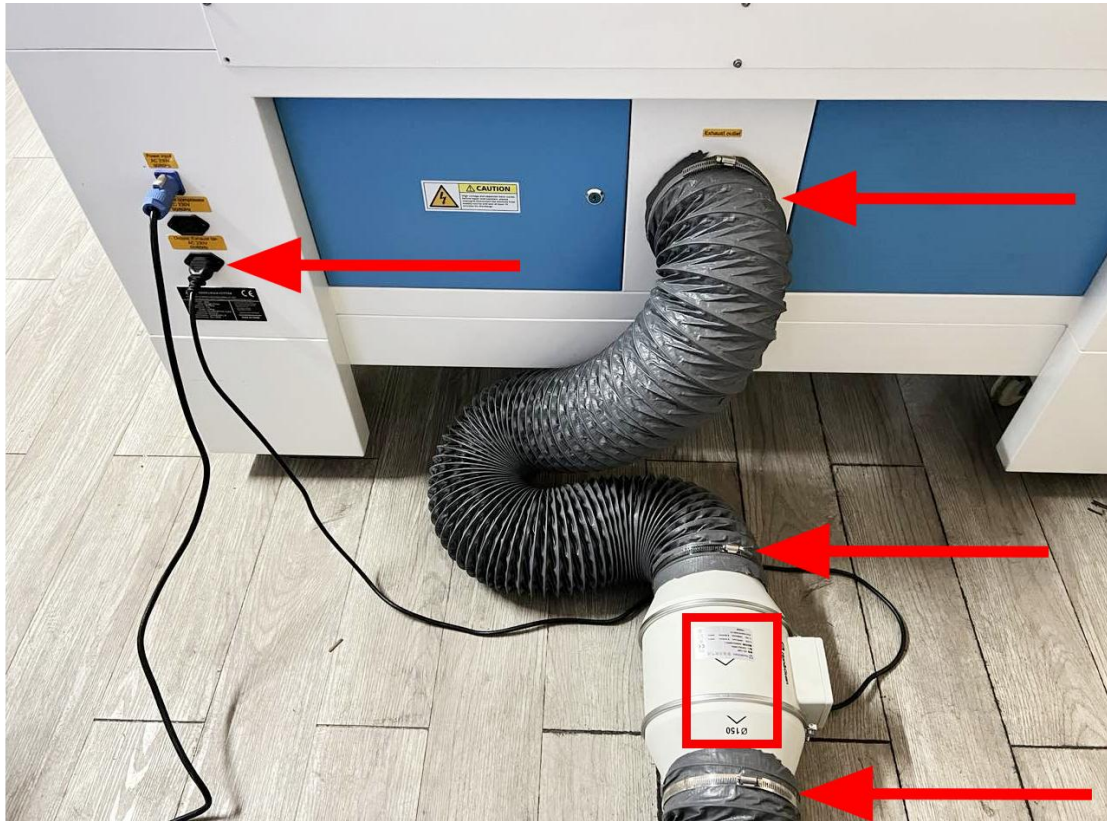

Also you can refer to the video on how to set up your Nova laser machine in our website

[How to setup your Nova laser cutter 2020 - YouTube](#)

The input voltage must correspond (AC 230V 50/60 Hz or AC 115V 50/60 Hz) – see information label beside the connection socket.

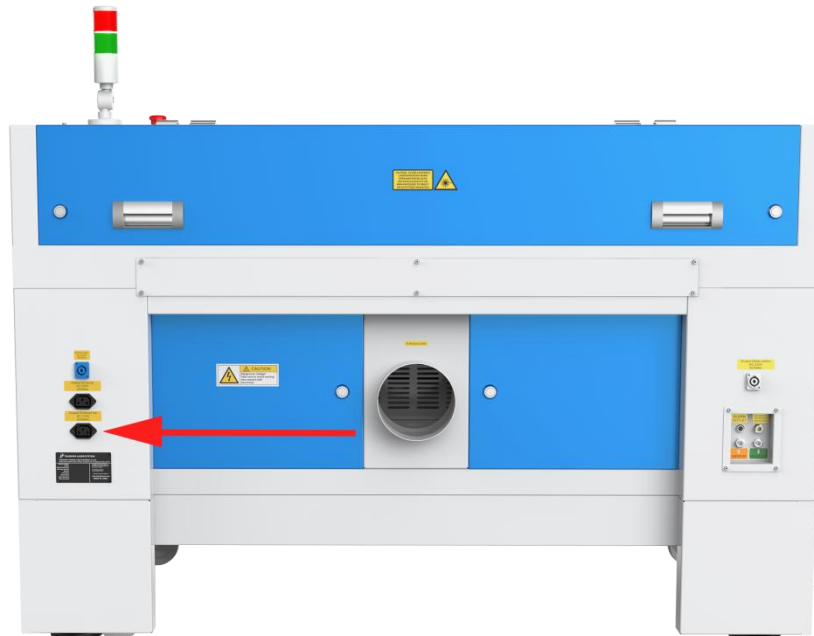

| | |
|---|---|
| Output: Exhaust fan AC 230V 50/60Hz | Output: Exhaust fan AC 115V 50/60Hz |
|---|---|



Do not connect the air compressor or the water chiller to the above interface, if connect them to the above interfaces that cause in failure of the machine, the warranty does not covered.

3.8.5 Connecting the Cooling System

- ① Open the Toolbox, and then take out the water pipes, water-error signal cable and chiller power cable.
- ② One of the water pipes, please connect to the water chiller where marked as "OUTLET", the other side of the pipe connect to the machine where marked as "Water IN".
- ③ The other pipe, please connect to "INLET" of water chiller and "Water OUT" of machine.
- ④ The Water-error signal cable, please connect to "ALARM OUTLET" of water chiller and machine.
- ⑤ The chiller power cable, please connect it from the laser machine to the chiller.



- ⑥ Add pure (distilled) water into the chiller until the water level in the green area showing on the gauge. Run chiller for a period of time, the water will fill into the laser tube on the machine, please re-add water to keep the water level in the green area.

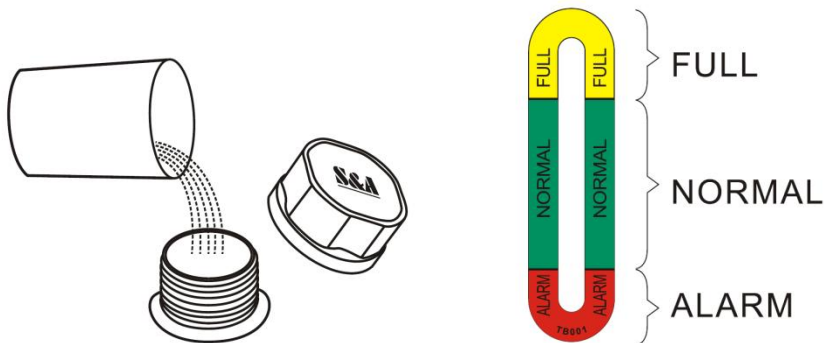



1. Please check again to make sure that the water inlet and outlet of the water pipe between the machine and the chiller are properly connected before starting to run the machine.
2. If the laser tube is filled with water and there are still some bubbles in the laser tube, please press the water inlet tube at the end of the laser tube to squeeze out the bubbles.

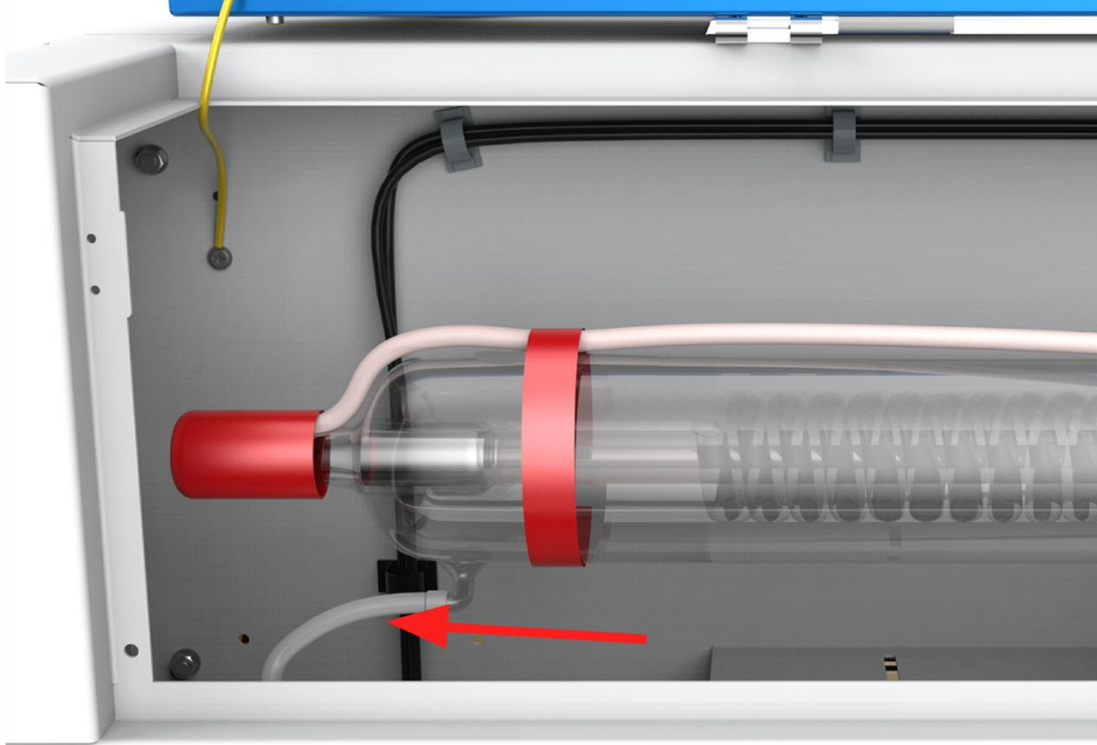

Chapter 4. Operation

4.1 Machine View

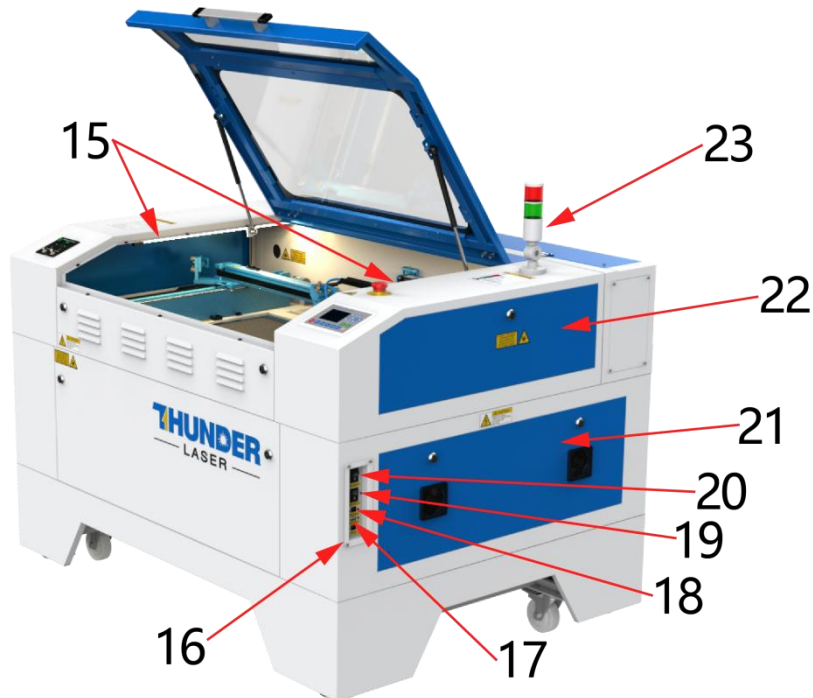
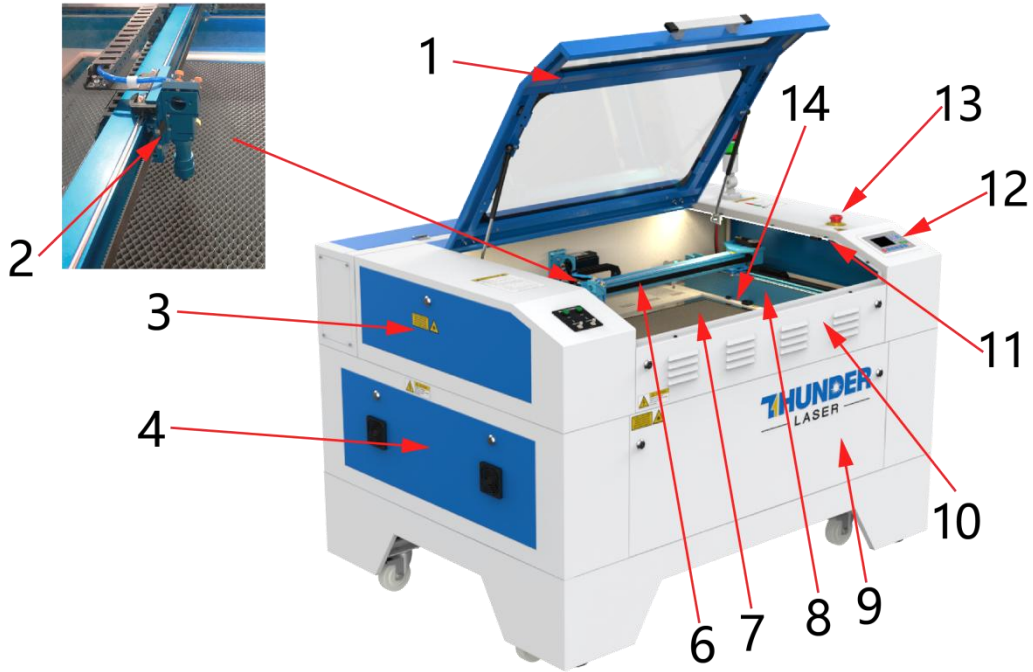

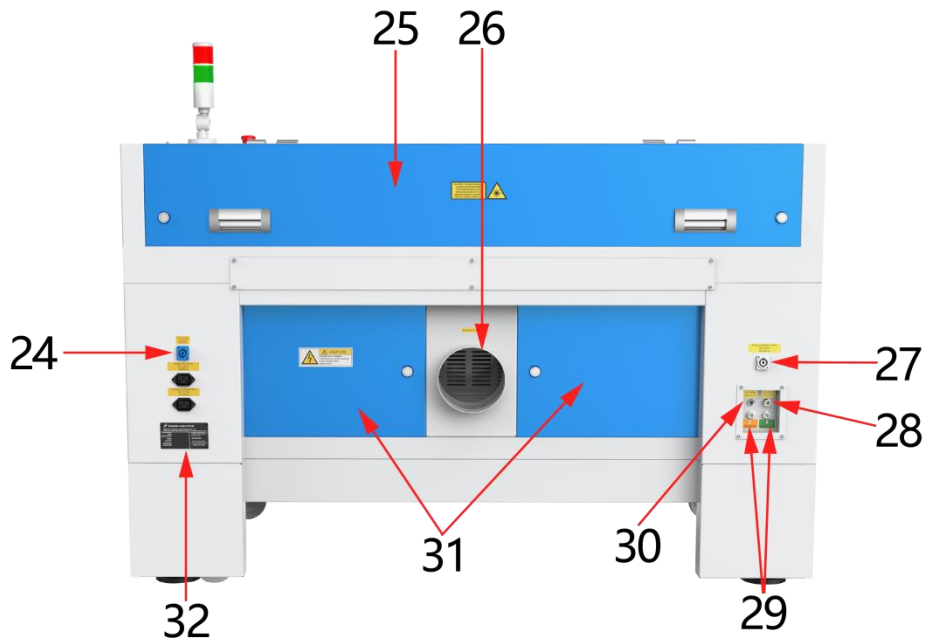

- | | |
|----------------------------------|---------------------------------------|
| 1. Top flap | 17. U-disk connection port (USB) |
| 2. Laser head | 18. Ethernet port |
| 3. Left-up side door | 19. Laser power switch |
| 4. Left side door | 20. Main power switch |
| 5. Dual air-assist control panel | 21. Right side door |
| 6. X-axis | 22. Right-up side door |
| 7. Honey comb table | 23. Alarm lamp |
| 8. Y-axis | 24. Power supply socket |
| 9. Front door | 25. Laser tube cover |
| 10. Front up door | 26. Exhaust hose |
| 11. Flap protection sensor | 27. Chiller power socket |
| 12. LCD panel | 28. Blow air port |
| 13. Emergency stop switch | 29. Water in and water out |
| 14. Auto focus sensor | 30. "No-Water protection" signal port |
| 15. LED lamp | 31. Rear door |
| 16. PC connection port (USB) | 32. Manufacturer's label |

1. Top flap

If the Top flap is opened, no data is processed. When the protection cover is opened during working, the motion system is stopped and the laser source is turned off. During processing of commands the protection cover must only be opened after pressing the "Pause" button.

2. Laser head

Laser beam and red dot pointer are all come out from the laser head.

3. Left-up side door

Open this door for cleaning the second reflective mirror or align that laser beam. This door is installed with the flap protection sensor.

4. Left side door

On nova24, there are installed the laser power supplier, Ammeter, Flap sensor checking board etc. Please open this door for checking these parts, but must pay attention to the electric current.

5. Dual air-assist control panel

You can adjust air volume for cutting or engraving if require. (Please view this chapter 4.9 for detail).

6. X-axis

The motion system is that performs the mechanical movements in X direction. The X-axis is visible in the working area.

7. Honey comb table

The honey comb plate sits on top of the blade bed and has indexing pins for alignment.

8. Y-axis

The motion system is that performs the mechanical movements in Y direction. The Y-axis is visible in the working area.

9. Front door

To clean the waste after working or remove the honey comb table. This door is installed with the flap protection sensor.

10. Front up door

Open this door to use pass-through door. This door is locked by using inside screws and outside locks.

11. Flap protection sensor

This is where Open flat protection exist. Laser will stop working once the cover is opened during working.

12. LCD panel

You can control the X-axis, Y-axis and Z-axis manually by the display panel, it also shows the working time, power, speed and the whole working time and affords many function options (Please view this chapter 4.3 for detail).

13. Emergency stop switch

Once there's an accident happen (laser catch fire, laser out leakage) during working, please turn off this switch immediately. It will be cut off the laser power and motion power immediately.

14. Auto-focus sensor

Used for the automatic focusing of the work table.

15. LED lamp

It's used for lighting the working table once turn the Main switch on.

16. PC connection port(USB)

This USB is for connecting computer.

17. U-disk connection port(USB)

You can save the file as a U-disk File by press "SaveToUFile" on the software, then save it to the u-disk and insert the u-disk to the port of laser machine, then use the control panel to select and control it to work

18. Ethernet port

This Ethernet port is for connecting computer.

19. Laser power switch

The laser power will be on while you turn it on.

20. Main switch

The laser machine will be start while you turn it on.

21. Right side door

On Nova24, there are laser controller, driver(Hybrid Servo Drive and Stepper Drive),TL-timer, and the main connecting cables etc.

On Nova35/51/63, there are laser controller, driver(Hybrid Servo Drive and Stepper Drive), power supplier (both 24v DC and 36vDC),TL-timer, flap sensor checking board and the main connecting cables etc.

Please open this door for checking these parts, but must pay attention to the electric current. If you need to repair, please contact with professional maintenance staff.

22. Right-up side door

Maintenance for the Emergency stop button if required. This door is locked by using inside screws and outside locks.

23. Indicate light

If laser machine is running a job or user starts it without closing door or water protection, the signal lamp is in red light. The red light indicates the dangerous situation and user must stay with the laser.

If laser machine is not at work, the signal lamp is in green light. The green light indicates the safety situation and the laser machine is ready for operation.

If temperature is higher than 55°C/131°F on working table, the signal lamp will make buzzing sound.

(roughly 80dBA within 1m,75dBA within 5m and 65dBA within 10m,the sound gets weaker as it travels).

24. Laser supply socket

To connect the main power and the extend power according the label information.

25. Laser tube cover

There are installed the laser tube, red dot pointer device, beam combiner and the first reflective mirror mount.

This door is installed with the flap protection sensor

26. Exhaust hose

This is for installing the exhaust device.

27. Chiller power socket

To connect the chiller power.

28. Blow air port

This port is for connecting hoses of the air compressor.

29. Water in and water out

Both ports are for connection with water pump or water chiller.

30. “No-Water protection” signal port

This port is connecting the chiller with the signal cable.

31. Rear door

On Nova24, there are power supplier (both 24v DC and 36vDC)

On Nova35/51/63, there are installed the laser power supply.

Please open this door for checking these parts, but must pay attention to that electric current.

32. Manufacture’s Label

It’s Show you the laser information like serial number or manufacturing date etc.

4.2 ON/OFF Switch

The mains and the laser supply power ON/OFF switch

The following conditions must be fulfilled for correct start up:

Unrestricted freedom of motion of the mechanics

No materials under the engraving table

Protection covers closed

When turn on the power of machine, and note that turn on the main switch first and then the laser supply power switch

When turn off the power of machine, and note that turn off the laser supply power switch first and then the main switch

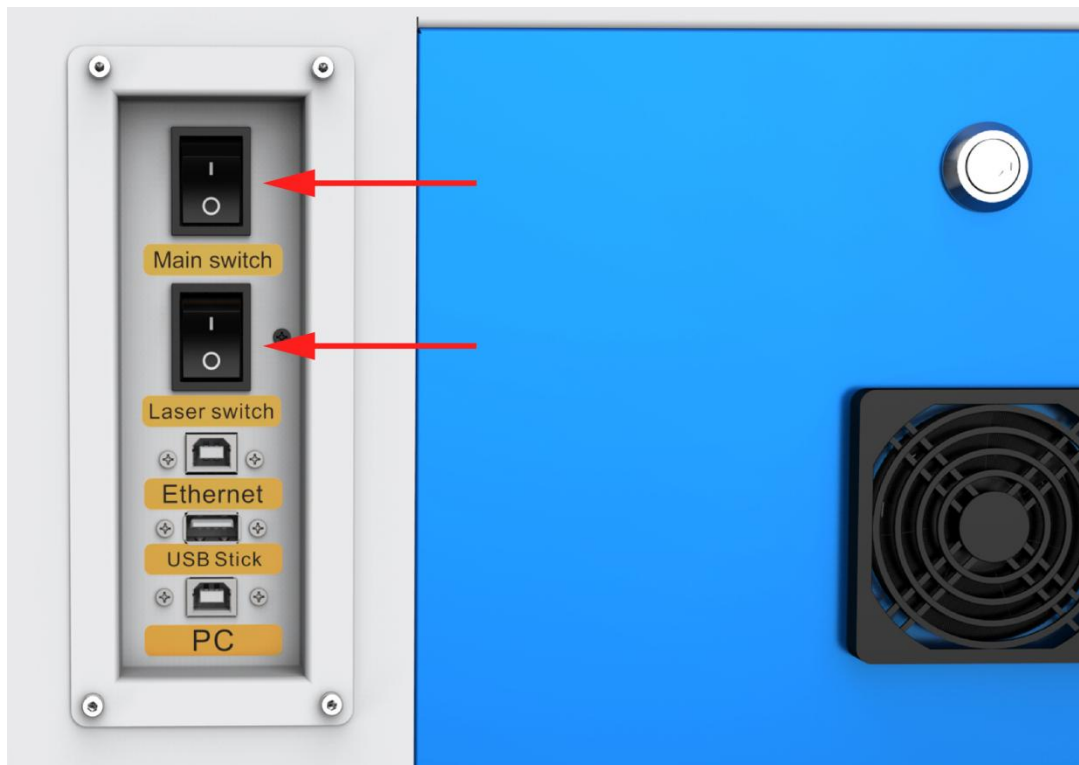

If all covers are closed, immediately after being switched on, the device starts the referencing process. When the referencing process is completed correctly, an acoustic signal sounds and the device is ready for operation. The operation panel will display the home screen when the laser is completed resets.



Before switching on the device, the user must make sure that no objects of any kind are located inside the operating space, which could limit or obstruct the mechanics of the device.

Please note that do not to press “ESC” button during the referencing process.

4.3 How to setup the OEM software

**PLEASE VISIT LIGHTBURNSOFTWARE.COM TO FIND RESOURCES FOR INSTALLING
LIGHTBURN**

4.3.1 Software installation

Your machine comes with a USB flash drive, which you will find many helpful application videos and instructions as well as the software for your machine.

To install the software, insert the USB flash drive into your PC and open the "Software" folder on the USB flash drive.

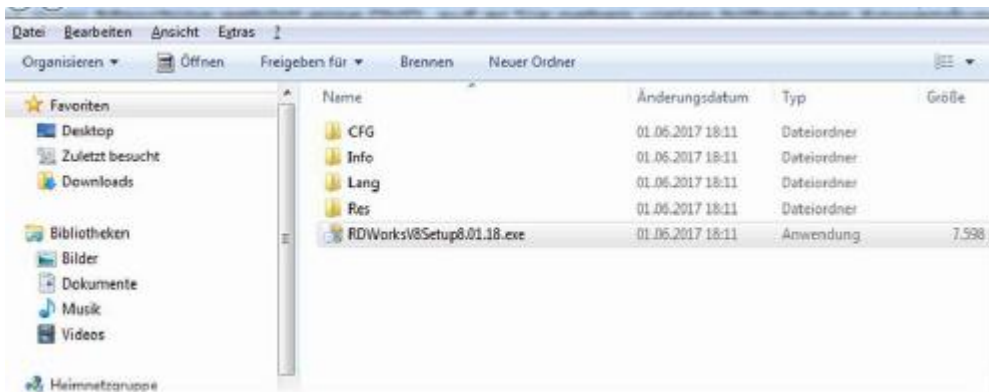

In this folder you will find the installation file "RDWorksV8Setup8.01.43.exe". Run this file by double-clicking on your PC.

Follow the installation menu until the window "Welcome to use" opens, like below.



If you use USB cable connection, please install the USB driver.

The type of the program offers different possibilities:

1. LaserWork: If you select this option, the laser software RDworksV8 will be installed on your computer.
2. CorelDraw_Laser: If you work a lot with Corel Draw, you can transfer your images and drawings directly to RDworksV8.

How to install the coreldraw plugin for RDworksV8, click below link for instruction

[How to import PDF files into RDWorks \(thunderlaser.com\)](http://www.thunderlaser.com/tech@thunderlaser.com)

3. AutoCAD_Laser: Select this option to install a plugin that can transfer the drawings directly from AutoCAD to RDWorksV8.

4. EngraveLab_Laser: Select this option and install a plugin that can transfer the drawings directly from EngraveLab to RDWorksV8.

Origin (zero point): This is specified by the machine and must always be selected "top-left" for Thunderlaser machines.

Size unit: Here you can choose between millimeters and inches.

Select installation path: Here you can select a different installation directory for your laser software. We recommend that you use the default settings, otherwise some operating systems may restrict the functionality of the software due to misinterpreted access rights.



After selecting your options, click "Install" and then brings up a window "Install Finish!". You can confirm this and then end the installation process.

A "RDWorksV8" icon will be automatically added to your Desktop, you are now ready to use the RDworksV8.



Trouble shooting for RDworks installation.

If you were unable to install the RDworks,it's possible that your Anti-Virus software is blocking installation.

Please disable all Virus and Spyware Protection Features. After the RDworksV8 has been installed go back into your Anti-Virus software and re-enable the setting that was disabled.

4.3.2 Make connection between PC and machine

- USB cable connection

Make sure that you have the USB driver installed during the installation process.



Make sure that you have your PC connected to the machine via USB cable,

Open RDworks, from right bottom corner of the software, set up the Device by Setting>>Device --- (USB: Auto).

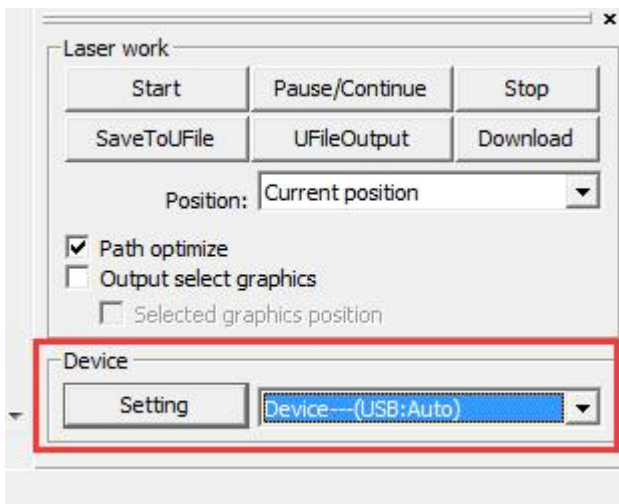

Your PC is now connected to the machine.



When connecting the machine and the PC for the first time, it may take a few minutes for the operating system to recognize the machine and install the driver.

- Ethernet cable connection

Make sure that you have your PC connected directly to the machine via Ethernet cable,



The machine is already assigned an IP address when delivered: 192.168.1.100

Now set up your PC so that it is in the same network and can communicate with the machine.

Please follow the instructions below for the setup process (For Windows7):

- 1). Click Windows Start > Control Panel.
- 2). Click **Network and Internet > Network and Sharing Center**. In the left pane, click **Change adapter setting**.

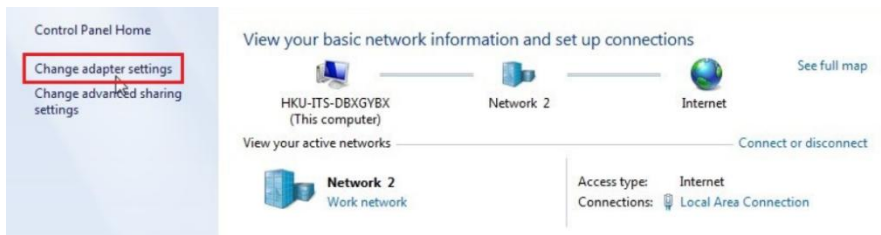

- 3). Right click **Local Area Connection** and then select **Properties**.

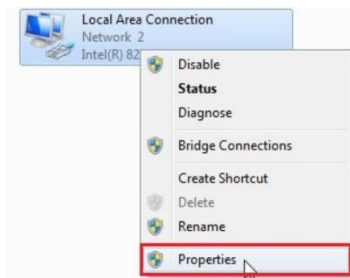

- 4). Under **Networking** tab, choose **Internet Protocol Version 4 (TCP/IPv4)** and then click **Properties**

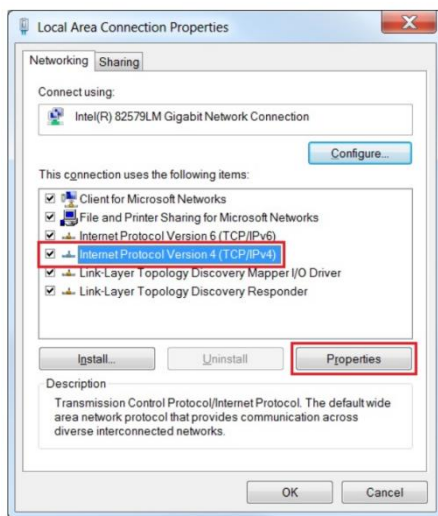

- 5). In "Internet Protocol Version 4 (TCP/IPv4) Properties" window, Select "Use the following IP address:"

Type IP Address: 192.168.1.1

And Type subnet mask: 255.255.255.0

Then click OK.

With this you have successfully created the prerequisites so that the machine and the PC can communicate via LAN.

Now open your RDWorks from right bottom corner of the software, set up the Device by Setting>>Device --- Add a "Device---(IP:192.168.1.100)".

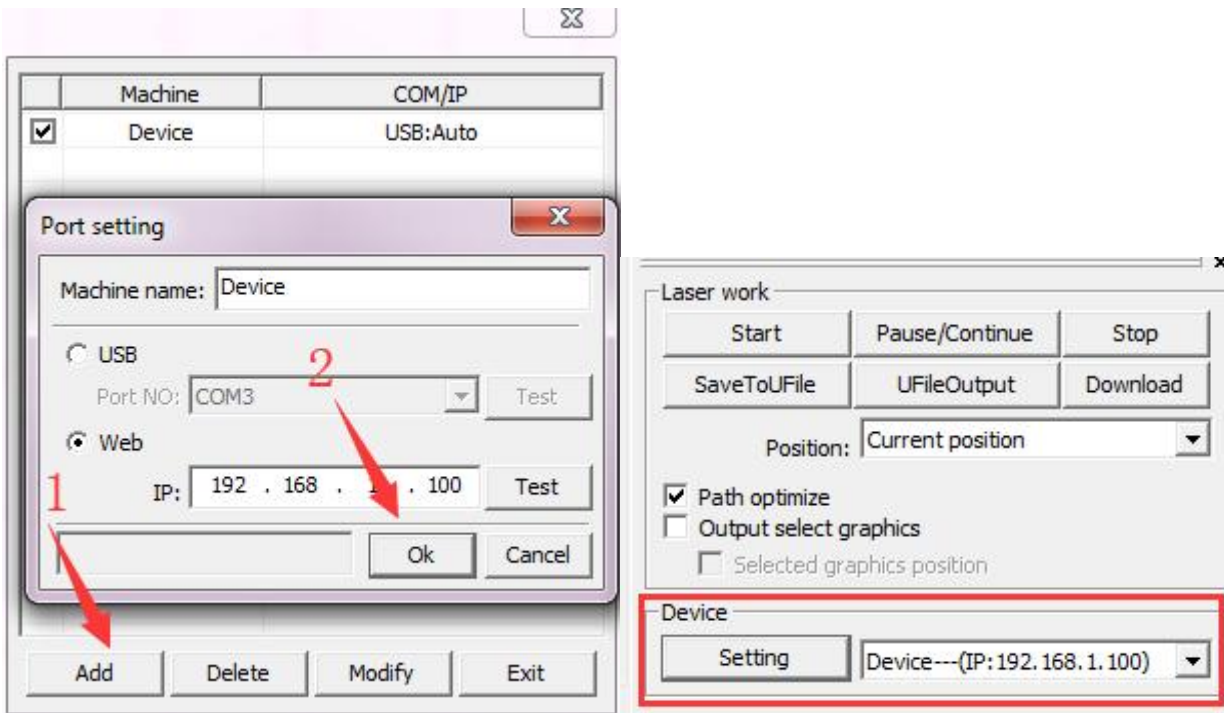

Now RDWorks communicates with your laser machine via LAN.

4.4 How to use the display

4.4.1 Function of the Buttons

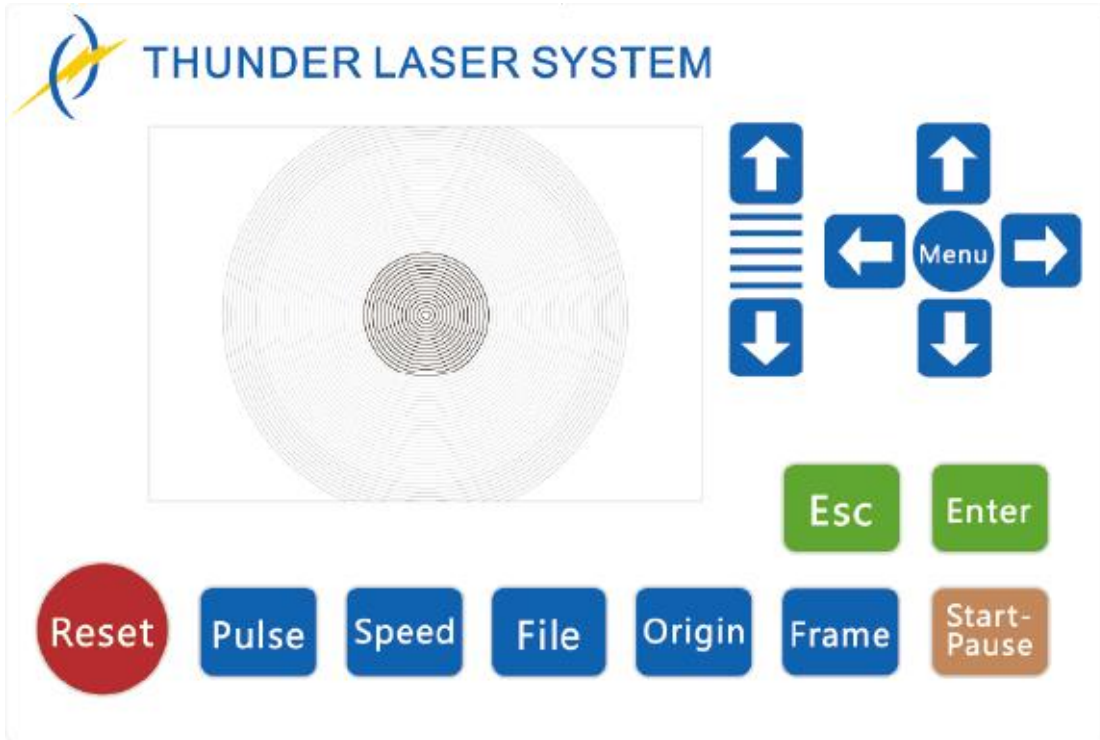

- ✧ Arrow buttons: control the movement of the Z-axis.



- ✧ Arrow buttons: control the movement of the laser head.(also can be used to change the parameters in the control panel)









- ✧ Menu button: The Menu key can be pressed when the system is idle or the work is finished. On pressing this key, it will show some entries in the interface, each entry includes some functions, U axes move, each axes to go home etc.



- ✧ Reset button: Reset the machine.



- ✧ Pulse button: Pulse a laser beam.

- ✧  Speed button: Set the speed of the current running layer, or *set the arrow buttons' move speed.*
- ✧  File button: The management of the memory and U disc files.
- ✧  Start-Pause button: run/pause the current job.
- ✧  Origin button: set the starting point for the laser head.
- ✧  Frame button: To track by the current file's frame.
- ✧  Esc button: To stop work, or return to the last menu.
- ✧  Enter button: confirm your selection.

4.4.2 The main interface

When the system is powered on, the screen will show as below:

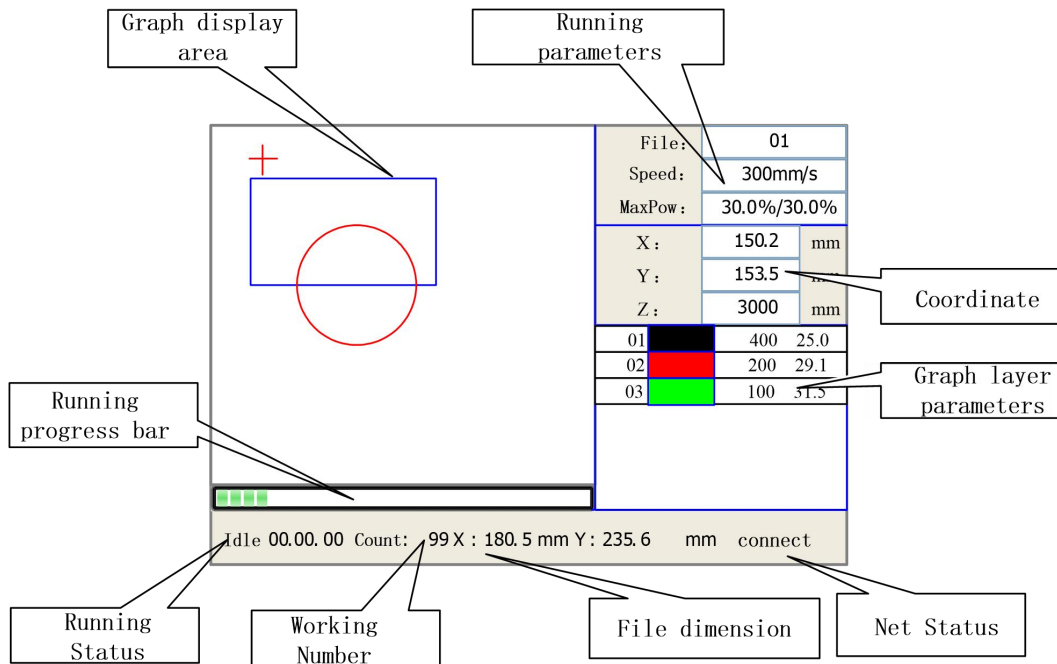

- Graph Display Area: To display the whole file's track, and display the running track.
- Running parameters: To display the running file's file number, speed, max power etc.;
- Coordinate: To display the current coordinate of X,Y and Z axes
- Graph layer parameters: To display the layers' information of the current file, such as max or min power, speed etc. When system is idle, double click the layer, then users can change the layer's parameters and the changing would be saved.
- Running Status: To display the current status of the machine, such as Idle, Run, Pause, Finish, etc.;
- Running Progress Bar: To display the progress bar of the current running file;
- Working Number: To accumulate the work number of the current file.
- File Dimension: To display the dimension of the current file;
- Net status: To display the connecting status of the Ethernet.

When work is Idle or finished, all buttons can be clicked, users can select a file to run, set some parameters, preview to a select file etc. But, when work is running or paused, some buttons don't respond when they are clicked.

4.4.3 Speed button

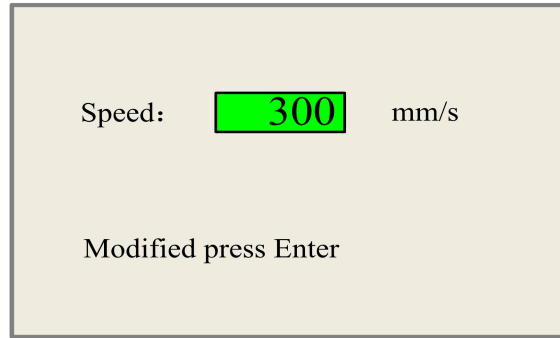

The speed can be set from 1~1000mm/s.

4.4.4 Max Power buttons

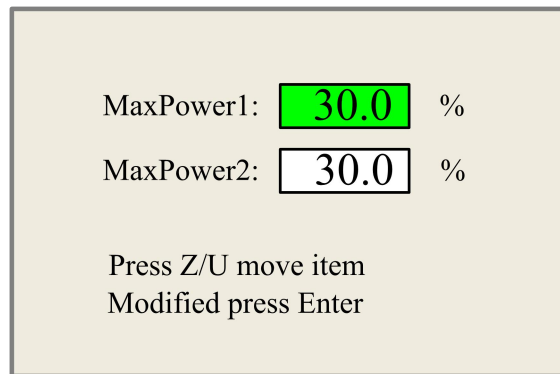

The max power can set the power for pulse button to shoot the laser beam, and max power2 is only for the double laser tube machine.

4.4.5 Set the Layer Parameters

After selecting a file to preview on the main interface, user can click "Enter" button to modify the parameter for the file from the machine.

| | | | |
|----|--|-----|------|
| 01 | | 400 | 25.1 |
| 02 | | 200 | 29.1 |
| 03 | | 100 | 31.5 |
| | | | |

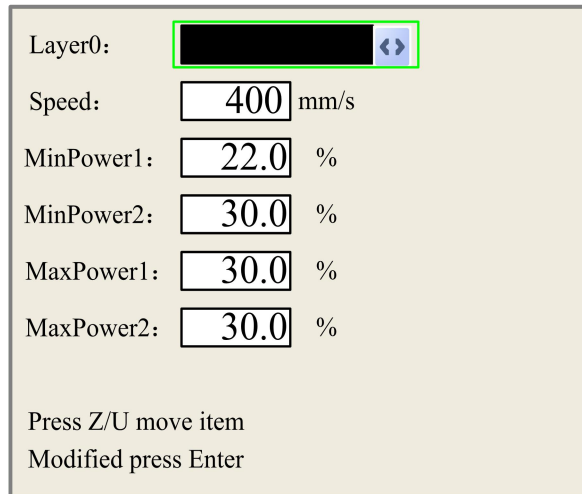

4.4.6 Menu button

The Menu button can be pressed when the system is idle or the work is finished. On pressing this button, it will show some entries in the following interface:

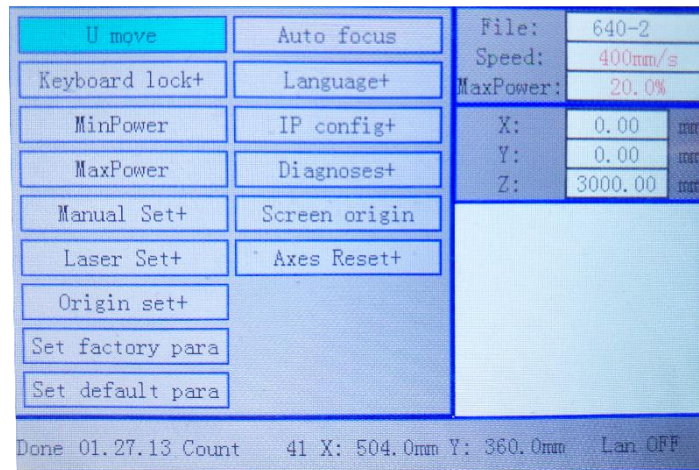

- U Move: When the green block is on “U Move” item, to control the rotary attachment to turn by pressing left and right arrow button.
- Axis Reset+: When the green block is on this item, you can manually reset the axis if needed.
- Set default para: To recover all manufacturer parameters and user parameters for your machine
- Auto Focus: To use the auto focus function.
- Language: The item “Language” helps you to select a appropriate langue which is displayed on the panel:
- IP Setup: The machine is already assigned an IP address as 192.168.1.100,and the IP address on software should be the same while communicate
- Diagnoses: the “Diagnoses” interface shows some system input information, such as limiter status, the status of the water protecting, and the status of the door protection etc.

4.4.7 File button

1). Memory File

On the main interface, if “File” button is pressed, it will show as below:

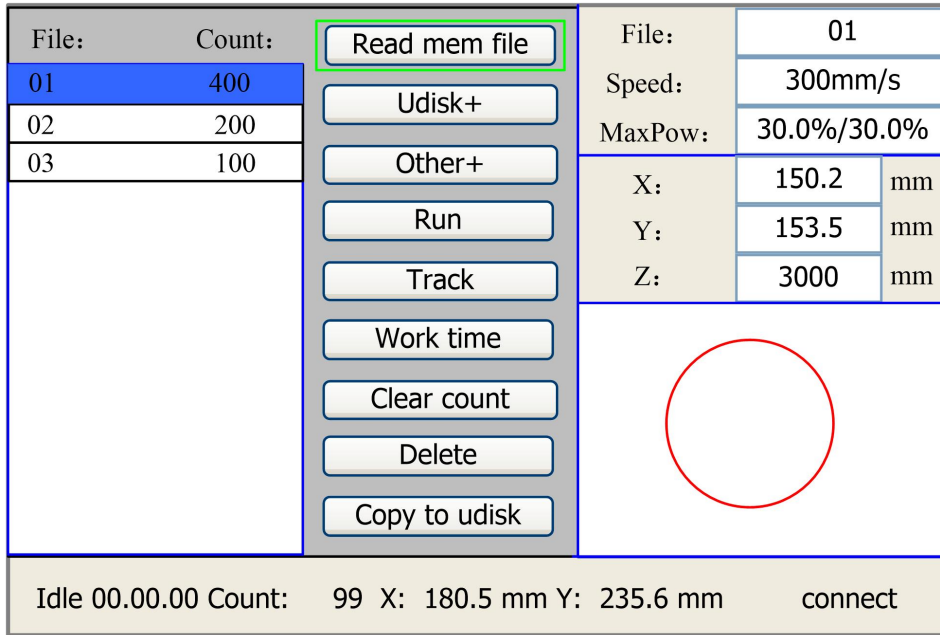

When showing this menu, the system would read the memory file firstly, the file name and the work times would be listed in the area, and the selected file is previewed in the bottom right area. “Y+/-” keys could be used to move the cursor on the file name list. When the cursor is on a target file name, presses the “Enter” key, the selected file will be previewed on the main interface, and then if “Esc” key is pushed, the preview will disappear.

“X+/-” keys could be used to move the cursor left and right. All the item show as below:

- **Read mem file:** read the memory file list;
- **Udisk:** read the U disk file list;
- **Other:** the other operation of the memory files;
- **Run:** To run the selected file;
- **Track:** To track the selected file, and the track mode is optional;
- **Work time preview:** To forecast the running time of the selected file, and the time is accurate to 1ms;
- **Clear count:** To clear the running times of the selected file;
- **Delete:** To delete the selected file in the memory;
- **Copy to Udisk:** To copy the selected file to Udisk;

If the “Other” entry is pressed, the system will show as below:

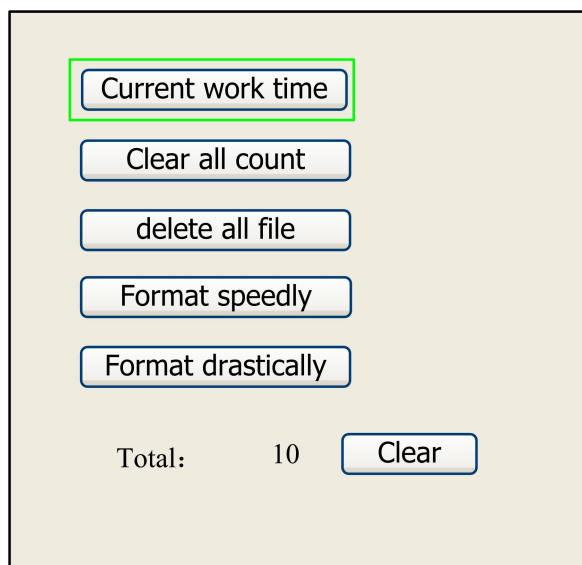

- **Current work time:** To forecast the running time of the current file(the current file No. is showed on the main interface), and the time is accurate to 1ms.
- **Clear all count:** To clear the running times of every file in the memory
- **Delete all file:** To delete all memory files
- **Format speedily:** To format memory speedily, and then all the files in memory will be deleted.
- **Format drastically:** To format memory drastically, and then all the files in memory will be deleted.

Total: the total running times of all the files.

2). U-Disk File

If the “U-disk+” entry is pressed, you can copy your file from USB flash drive to your machine.

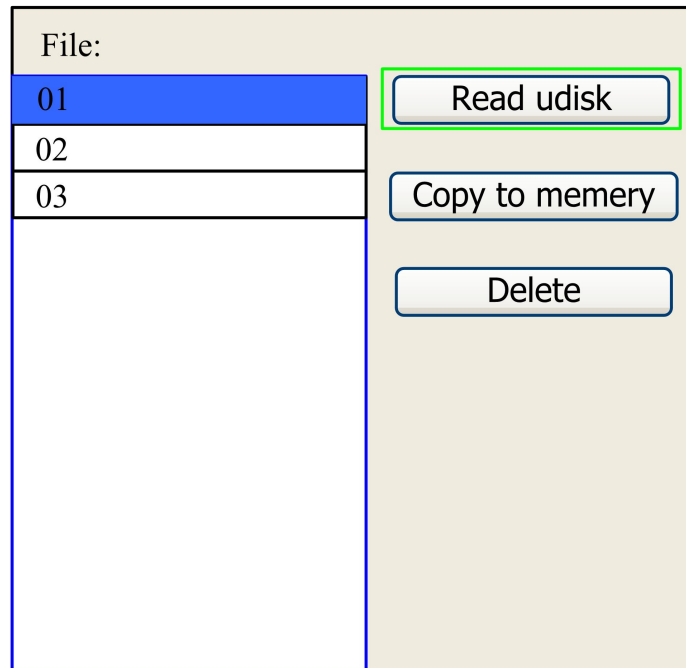

- **Read U disk:** read the file list in the U disk;
- **Copy to memory:** copy the target U disk file to the memory;
- **Delete:** delete the selected U disk file;



The controller can only compatible with USB 2.0 and at most 16G USB flash drive. For USB flash drive,you can use the one came with the machine to copy the file to your machine

The file should be .rd file and it's created by the “SaveToUFile” key on the RDworks.

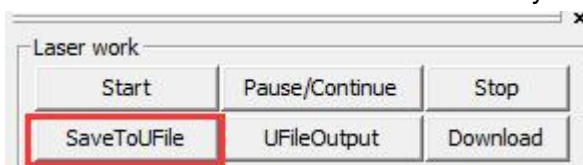

4.5 How to use the different nozzles laser head cone

The standard laser head is equipped with a 2 "(50.8mm) focusing lens and focuses the laser beam to a diameter of about 0.14mm (when using a glass laser tube).

With this laser head, you can perform fine engraving work (such as letters with 1.5mm height) and cut materials up to 10mm thickness with good quality (depending on the laser power of the machine).

The standard laser head is supplied with 2 air nozzles laser head cone.



A nozzle has a very narrow outlet (approx. 2mm), which provides high air flow to blow directly on the cutting gap. This nozzle is excellently suited for cutting wood, as this prevents soot formation in the cutting gap.

The other nozzle has a large outlet (approx. 6 mm), which provides the air assist to blow the material more slowly and not directly on the cutting gap. This nozzle is excellently suited for cutting acrylic, as this prevents white mark in the cutting edge. Besides, when engraving wood, for example, particles that have been removed and smoke / gases are gently distributed and extracted in the working area. So you get a clean, almost unaffected by smoke traces engraving.



The 6mm nozzle laser head cone are placed inside the toolbox.

4.6 How to replace the 4 inch and HR laser head

Both 4 inch laser head and HR laser head are optional item.

The 4 inch laser head is suitable for cutting materials with a thickness > 10mm.

With this look, you can achieve vertical cuts in 20 or 30mm thick materials, such as PU foam, acrylic or wood.

The High Resolution head can focus the laser beam much finer than the standard laser head.

This allows very delicate engraving or extremely precise cuts in films, cardboard or paper.

For cutting materials thicker than 1mm, the HR head is not suitable.

1) How to replace the 4 inch laser head

1. Move the table down till there's enough space to take the standard head out and install the 4" laser head.

2. Remove the standard head like below:

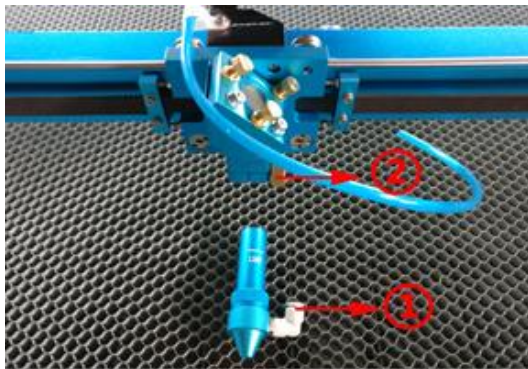

① Take out the air hose

② Loosen the screw

3. Install the 4" laser head like below:

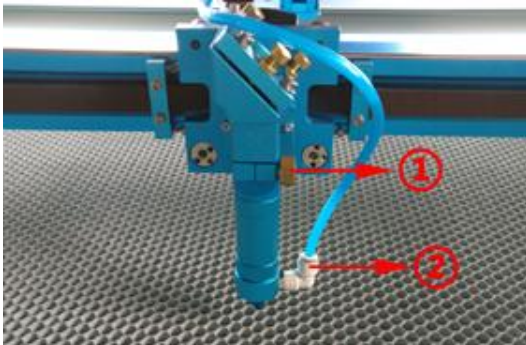

① Fix the laser head

② Connect the air hose



Please always insert the 4" laser head as far as it will go.

2) How to replace the HR laser head

1. Move the table down till there's enough space to take the standard head out and install the HR head.
2. Install HR head, like below:

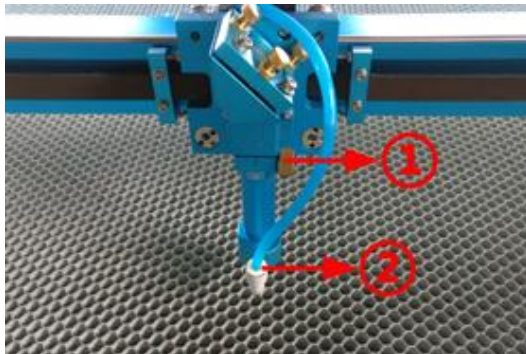

- ① Fix the laser head
- ② Connect the air hose



Since HR head is sensitive for focus distance, it's suggested to adjust the focus by manual rather than auto focus.

4.7 How to adjust focus distance by manual or auto

1) How to adjust focus distance by manual

1. Standard laser head:

The focus distance between the standard laser head and the material is 6mm.

Find the 6mm thickness Acrylic Focus Ruler for help to adjust the focus directly like below:

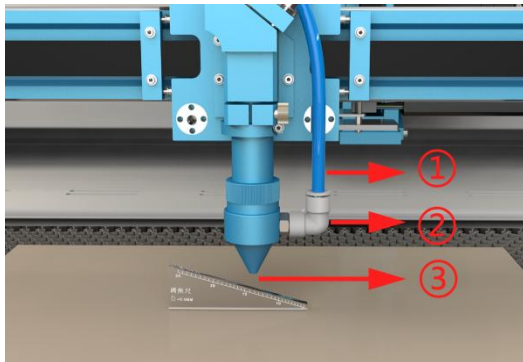

- ① Working Table
- ② Material
- ③ Focus Ruler

Please locate the laser head to where it stops by the stop ring. So as to protect the laser head from crashing into the honey comb table while z-axis does reset/auto focus

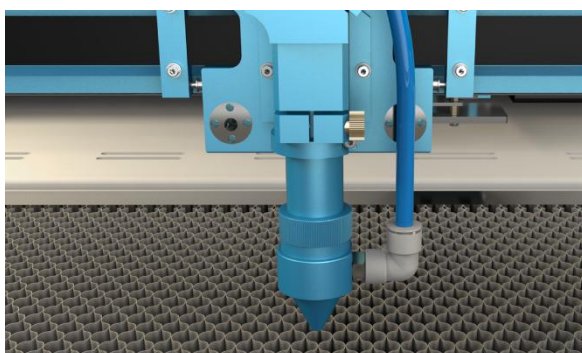

2. HR laser head

The focus distance between the HR laser head and the material is 3.5mm.

Since HR head is very sensitive for focus distance, thus we've tested and made a special focus tool (with a best distance) for each HR head, like below:

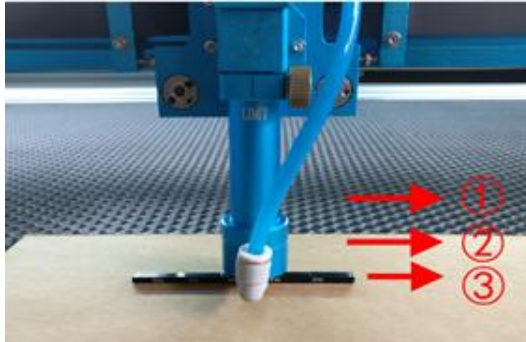

① Working Table

② Material

③ Focus Tool

3. Four inch laser head

The focus distance between the 4" laser head and the material is 10mm.

4" laser head is not so sensitive for focus distance; you can set the distance about 10mm~12mm with the help of focus ruler, like below:

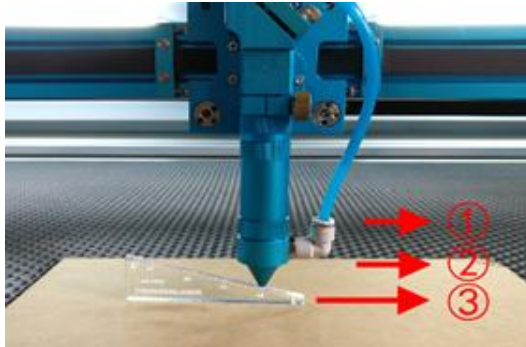

- ① Working Table
- ② Material
- ③ Focus Ruler



Please always insert the 4" laser head as far as it will go.

2) How to adjust focus distance by Auto

The Standard laser head will be provided with a stop ring. Always insert the laser head as far as it will go, so that the correct focus distance is set during automatic focusing.

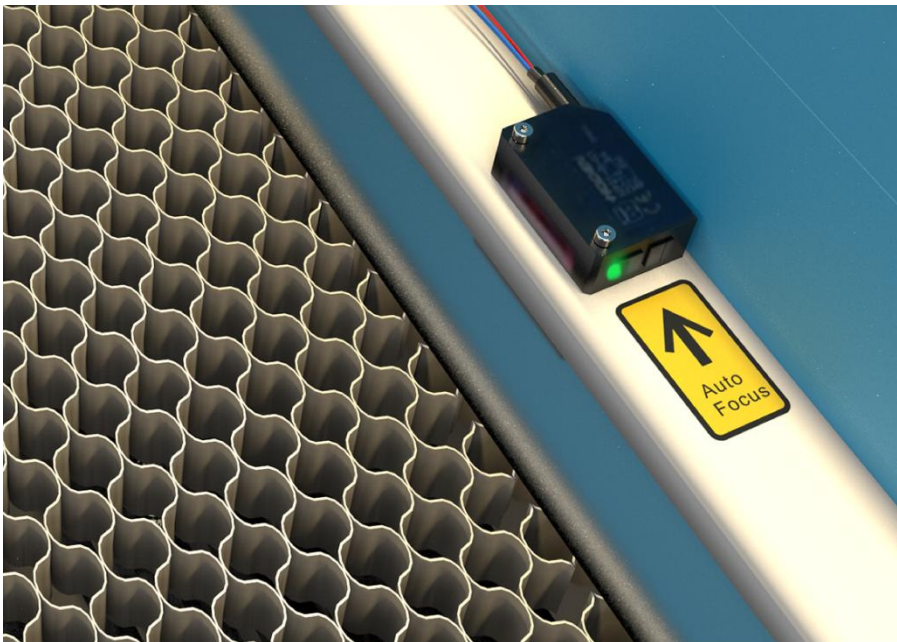

Move the table down till there's enough space, then place the material between the auto focus sensors.

Make sure you always insert as far as the laser head stops by the ring.

After that, go into Menu button>>Select Auto Focus.

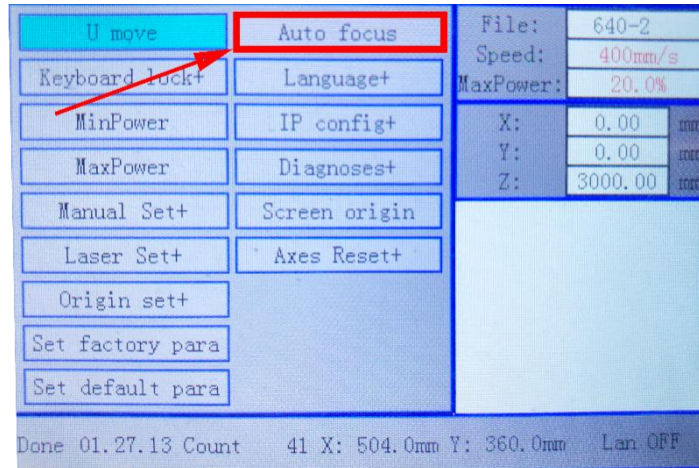

Do not use “auto focus” function while using HR laser head or 4” laser head or a rotary device.

Do not use “auto focus” function while using transparent materials.

The “auto focus” function only valid for standard head with a stop ring installed and adjusted to the correct position.

Also you can refer to the video instruction below:

[The basics of focussss](#)

4.8 How to use the TL-Timer

The TL-Timer is an additional tool for laser machines.

It will control laser machines periphery like air pump, exhaust fan, warning lights, heat alarm detector, electrical locks and lot of other stuff automatically.

This will increase the ease of use of your laser machine.

About TL-Timer controller interface and buttons description:

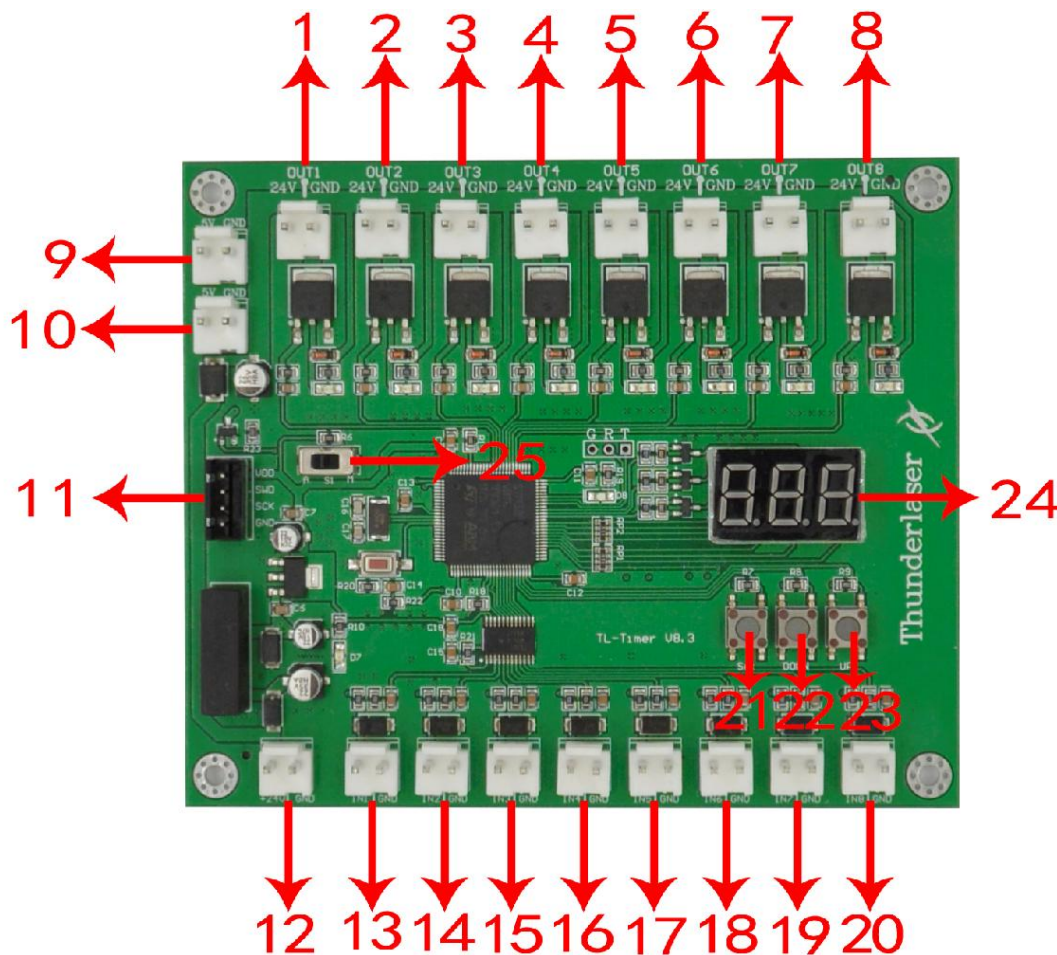

1. OUT1: Control the green light of warning light; When the machine is not at work, the warning light is in green color;
2. OUT2: Control the red light of warning light; When the machine is working or getting around alarm message on LCD panel, the warning light turns red;
3. OUT3: Control the exhaust fan; Delay shutdown is set to 30 second (Factory default settings, change it if required) ;
4. OUT4: Control air assist with "Low volume"; Delay shutdown is set to 20 second (Factory default settings, change it if required) ;
5. OUT5: Control air assist with "High volume"; Delay shutdown is set to 20 second (Factory default settings, change it if required) ;
6. OUT6: Control the fire alarm system; When A high temp is detecting on working area, the alarm system will be active, the warning light alarms and the machine stops working immediately;
7. OUT7: Control the power for rotary device;
8. OUT8: Spare interface;

9. 5V DC Voltage Power Output 1, control the power for red light pointer;
10. 5V DC Voltage Power Output 2, spare interface;
11. Upgrade interface;
12. 24V DC Voltage Power Input;
13. In1: "Working state" interface;
14. In2: Spare interface;
15. In3: Air-assist mode selection;
16. In4: Control air assist with "Low volume";
17. In5: Control air assist with "High volume";
18. In6: Temperature detection;
19. In7: Rotary connection state detection;
20. In8: Spare interface;
21. "Set" button, select each "OUT" interface and confirm the setting;
22. "DOWN" button, reduce time of delay shutdown;
23. "UP" button, increase time of delay shutdown;
24. LED lights display, set the delay time for viewing each interface and enter;
25. Auto and manual mode switch;

The TL-Timer is installed inside the lower right hand door panel, see below.

Operation:

Normal use:

The TL-Timer is selected Auto mode as factory setting.

Under Auto mode, when the laser is not at work, air assist and exhaust fan won't be on; When the laser is working, the air assist and exhaust fan starts, after the job finished, the air assist will stop after 20 second, exhaust fan will stop after 30 second.

Under Manual mode, when the laser is powered on, the air assist and exhaust fan will be on all the time

Each "OUT" interface has a freely adjustable delay time from 0-99 seconds.

Set up delay time:

Generally, there's only need to set up the delay time for air assist and exhaust fan, so they can be delay to shutdown according to your need. The default for air assist is 20 second, and for exhaust fan is 30 second.

Click "Set" button to select from OUT1 to OUT8 interface and the LED light display will show you the delay time in second for each interface. On each interface, click "down" or "up" button you can change the value, then click "Set" button to confirm and go into the next interface. On the OUT8 interface, click again the "Set" button, the display will be off and exit the delay time setup.

4.9 How to use air-assist control (IF EQUIPPED)

The Air-assist control is an additional tool for laser machines.

Generally, cutting needs the air assist with high air-volume but engraving needs the air assist with low air-volume. Air-assist control is available in high- and low-volume for engraving and cutting-jobs via software-setting, this will increase the ease of use of your laser machine.



1) How to select the air assist with high volume or low volume?

In RDworks software, high volume or low volume is selected on the “Air-Assist Control” option. We suggest select “High” for cut mode and select “Low” for scan mode (engraving mode).

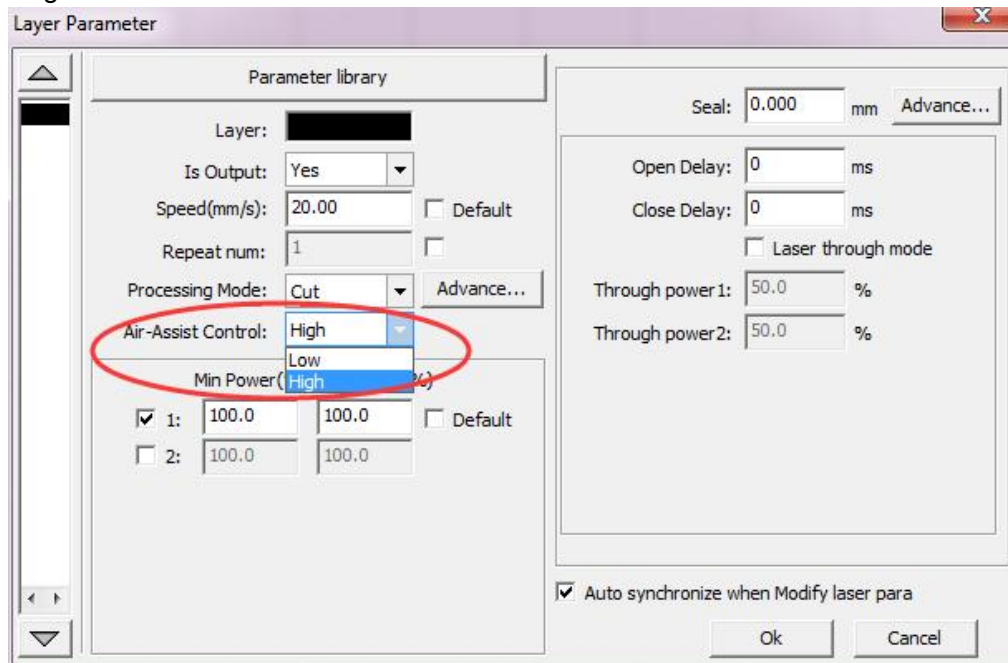

You can also set default for “Air-Assist Control” option, so in cut mode, it will select High volume automatically, and in scan mode (engraving mode), it will select Low volume automatically.

How to set default for “Air-Assist Control” option?

Go into the RDworks's root directory>>open the text file of "soft">>change the setting of "ShowBlow">>save the text file, like below.

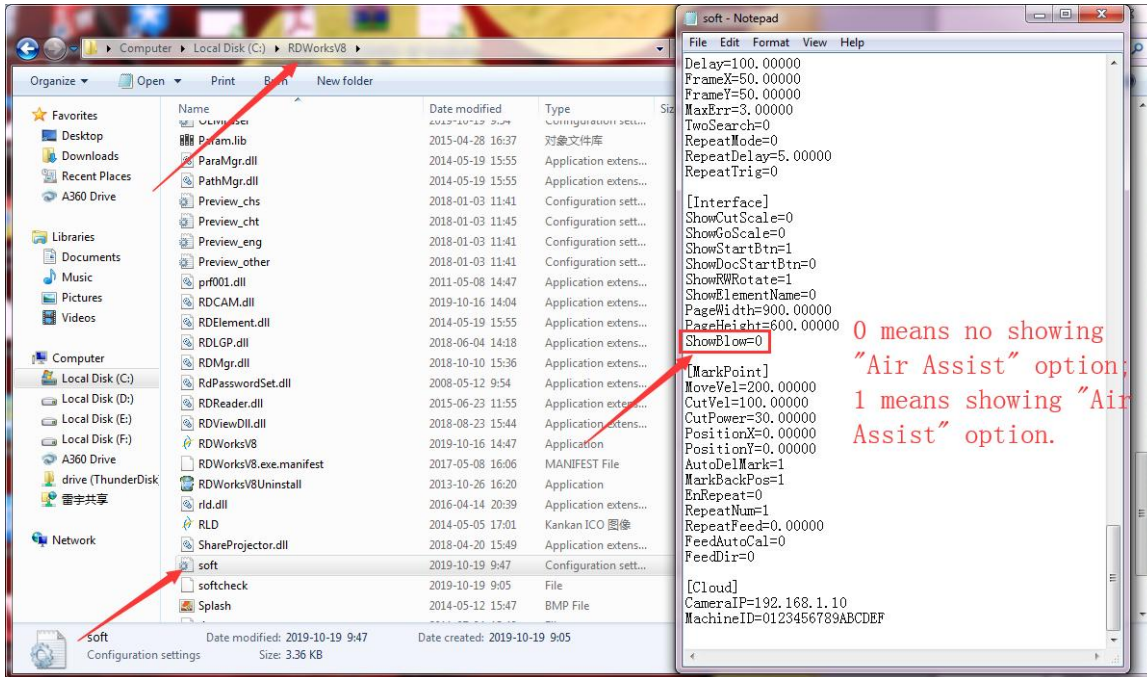

2) How to adjust air volume if require?

For High volume mode,

1. Make sure machine is not at work and laser switch is off
2. Click the left green button to start the air-assist with high volume
3. Check the air volume under the laser head
4. On left flow control valve, loose the locked nut then rotate the adjusting screw to control the air volume to mean your requirements.
5. Fix the locked nut after finished.

And for Low volume mode, you do it the same.



It will be the best if using big air compressor instead of air pump for air-assist.



Also you can refer to the video instruction below:

<https://youtu.be/GmiphyCBP3w>

4.10 How the heat alarm system works

The heat alarm system is an additional tool for laser machines.

Some materials such as acrylic, wood and so on, can easily catch fire, particularly during cutting.

The heat alarm system has a smart board with temperature sensor which will be reacted by an abnormal temperature (higher than 55°C/131°F) on working table. It will trigger at a certain temperature then signals to TL-Timer board to stop laser processing and give a warning sound, so operator can active fire control in time to reduce the potential losses and risks.

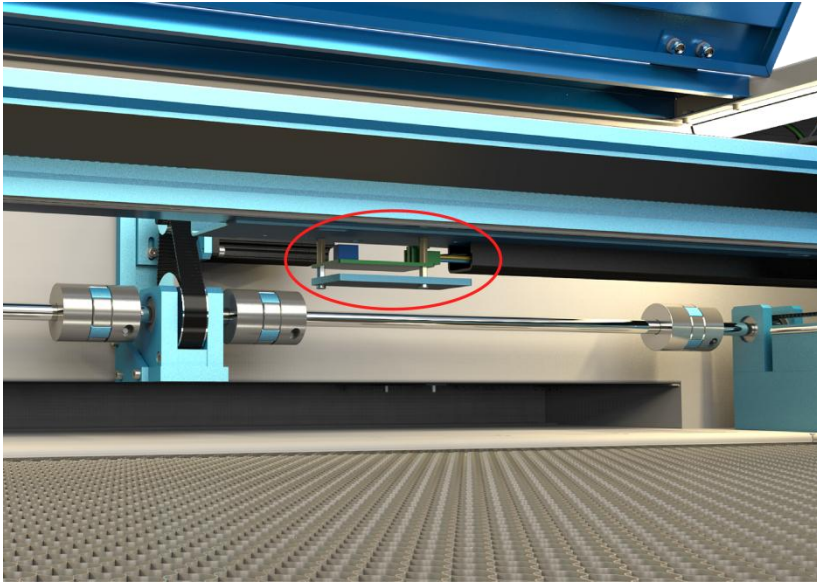

The warning sound comes from signal lamp (roughly 80dBA within 1m, 75dBA within 5m and 65dBA within 10m, the sound gets weaker as it travels).



When heat alarm system is activated, the warning sound will beep all the time until user restart the machine.

Fire Hazard: High potential for fire. NEVER RUN UNATTENDED.

4.11 The First Time Running the Laser



To be safe, never ever run the laser system unattended.



According to international standard, “O”means close; “I”means open for the rocker switch below

Yours first engraving tests

The following steps describe how to successfully engrave a first pattern. Please follow the individual steps:

1. First switch on the water chiller.
2. Switch on you Laser and wait for a beep to note the machine is initialized, and the laser head will do the reset and find the home from top left corner. **DO NOT** click “ESC” button to stop the system initialization.



When turn on the power of machine, and note that turn on the Main switch first and then the Laser switch.

3. After machine finish resetting, adjust the height of working table, place the material usually on the top left corner of the working table.
 - ① Move down the working table;
 - ② Place the material;
 - ③ Move up the working table;
4. With the help of the focus ruler, adjust the focus distance to 6mm between the bottom of laser head and the material manually by move up and down the working table.
5. Open the software RDworksV8.First to set up the values on the “Scanning(Reverse compensation)” check box. Open Config(s)>>system setting>>Optimize>>Scanning(Reverse compensation),and there are some default values on the “Scanning(Reverse compensation)” check box.

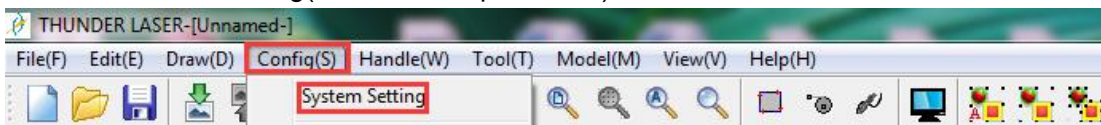

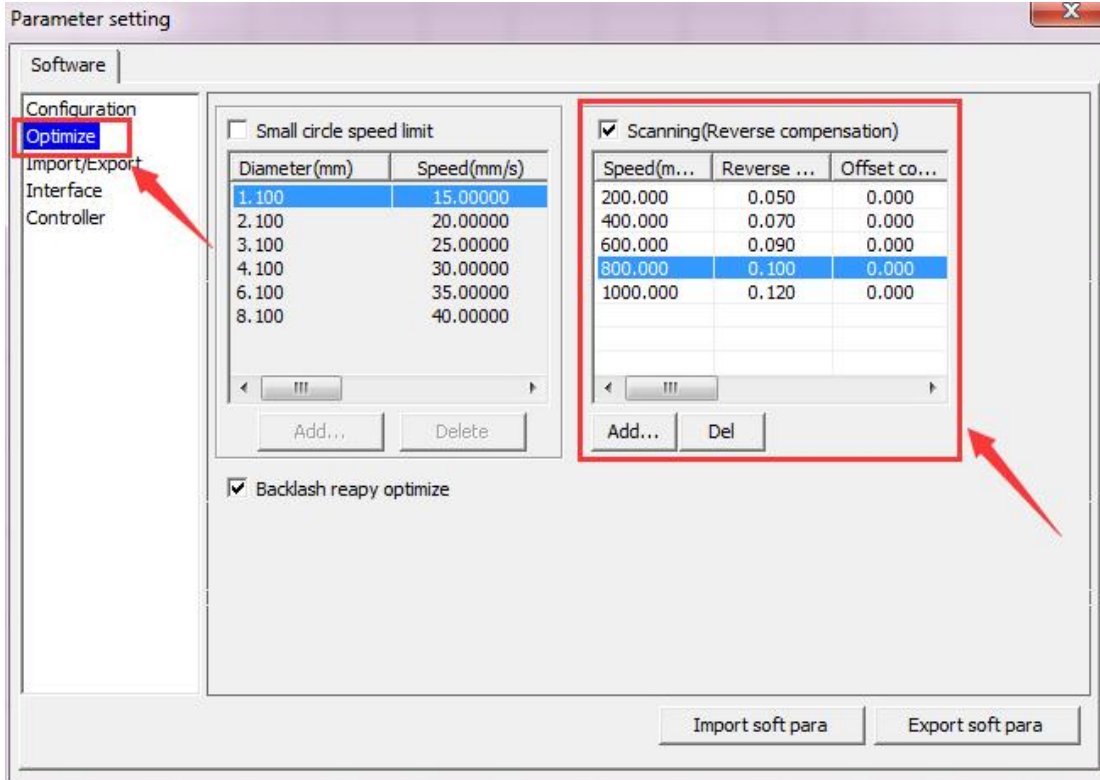

The particular values are showing with a picture in folder of laser software on the USB flash drive and on the Anodized aluminum piece that came with your machine.

Save those setting on the “Scanning(Reverse compensation)” check box.

6. Create sample text for engraving directly on RDworks, then set up the parameter and download the file to your machine.

More details for how to use software please watch the instruction video below.

How to prepare your files for feeding into the laser program to engrave

7. Click “Original” and “Frame” on the display, please make sure that the material is in the right location and there is enough space for working.

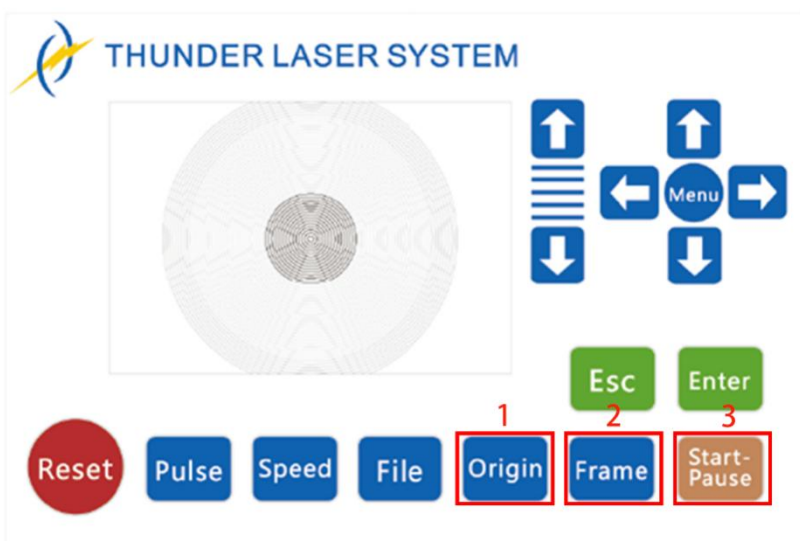

- ① Control arrow button to move the laser head;
- ② Click “Origin” button to select the start point;

- ③ Click “Frame” button to be sure the working area;
 - ④ Click “Start-Pause” to run the program;
8. Please check the water cooling system is working properly; the water is running into and filling the laser tube. Please do not start your work if the laser tube isn’t full of water, because that may led to laser tube damage due to the high temperature.
9. Finally press the “Start-Pause” button in the display, to start the engraving process.
10. While the laser is engraving, you can generate the next graphic.
11. When the engraving is complete, the laser machine will give out the notification sound and the laser head will go back to the original point, and the warning light will return to the green light, then you can repeat engraving.



This is software specific, so if you are using LightBurn, you will need to do this in LightBurn. It is called “Scanning Offset Adjustment.”

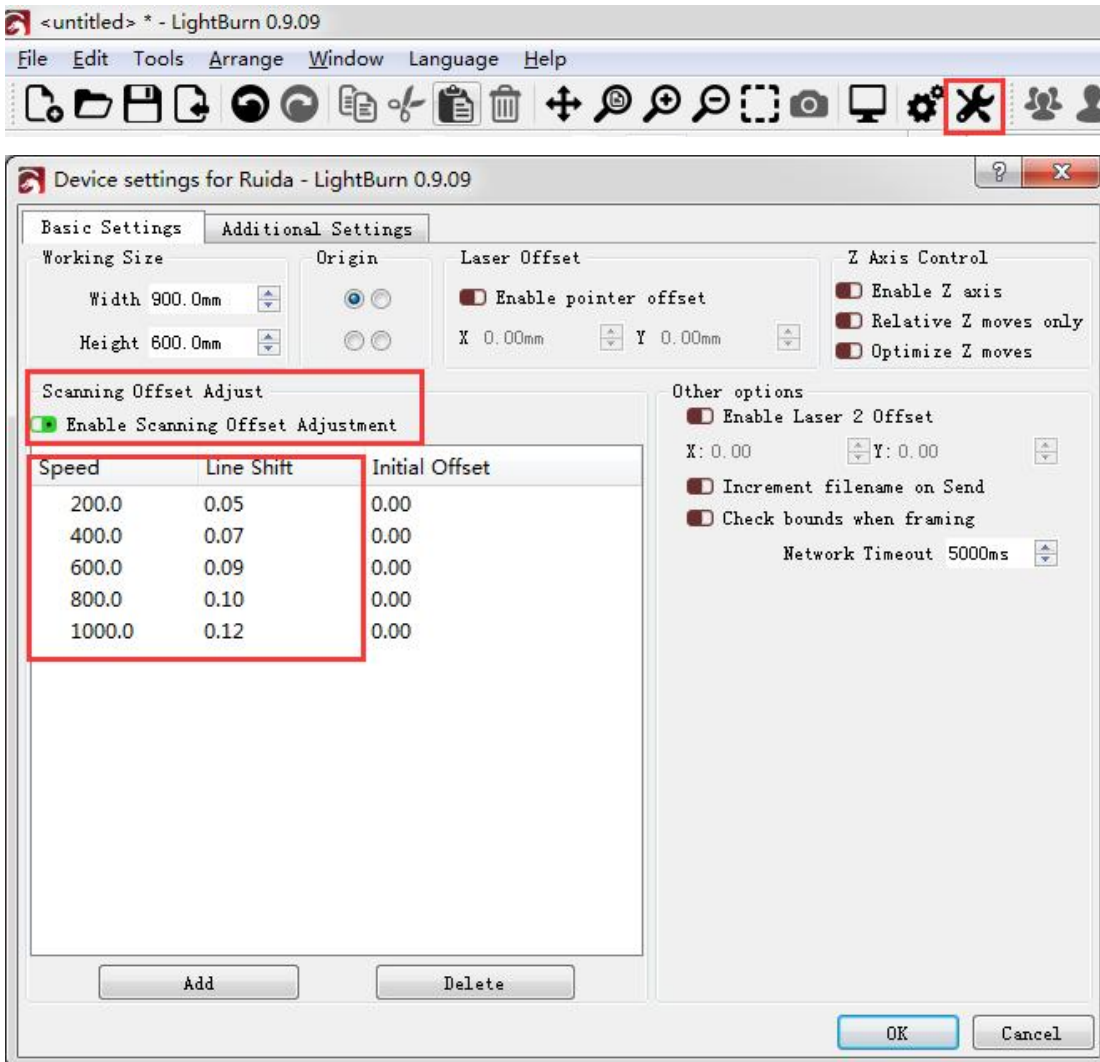

4.12 Workstation Area Indication

Side view



Workstation area occupied by operators

Plan View



Workstation area occupied by operators

4.13 How to use the Chuck Rotary axis Attachment

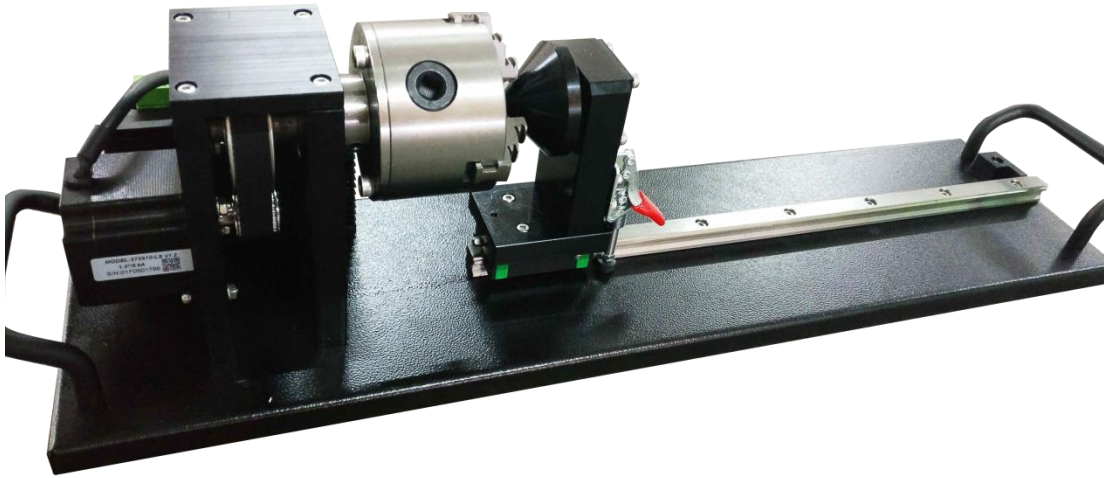

The chuck rotary axis attachment is the optional item.

Specification:

| | |
|----------------------|--------------------------------------|
| W×D×H | 23.62"×5.91"×6.69"/600mm×150mm×170mm |
| Max working length | 11.42"/290mm |
| Max working diameter | 3.94"/100mm |

To install and set-up the rotary axis attachment proceed as described as follows:

1. Move the working table to the lower position then switch off the laser and open the top lid.
2. Put the rotary axis attachment onto the working table and align the rotary attachment with the x-axis are parallel, with the jaw chuck closest to where the rotary attachment plugs in.
3. Connect the rotary axis attachment via the control cable with the connector of the motion system. The connector is located inside the right front of the laser. Connected it to this interface and fixed, and then you have finished the device connection. Like below:

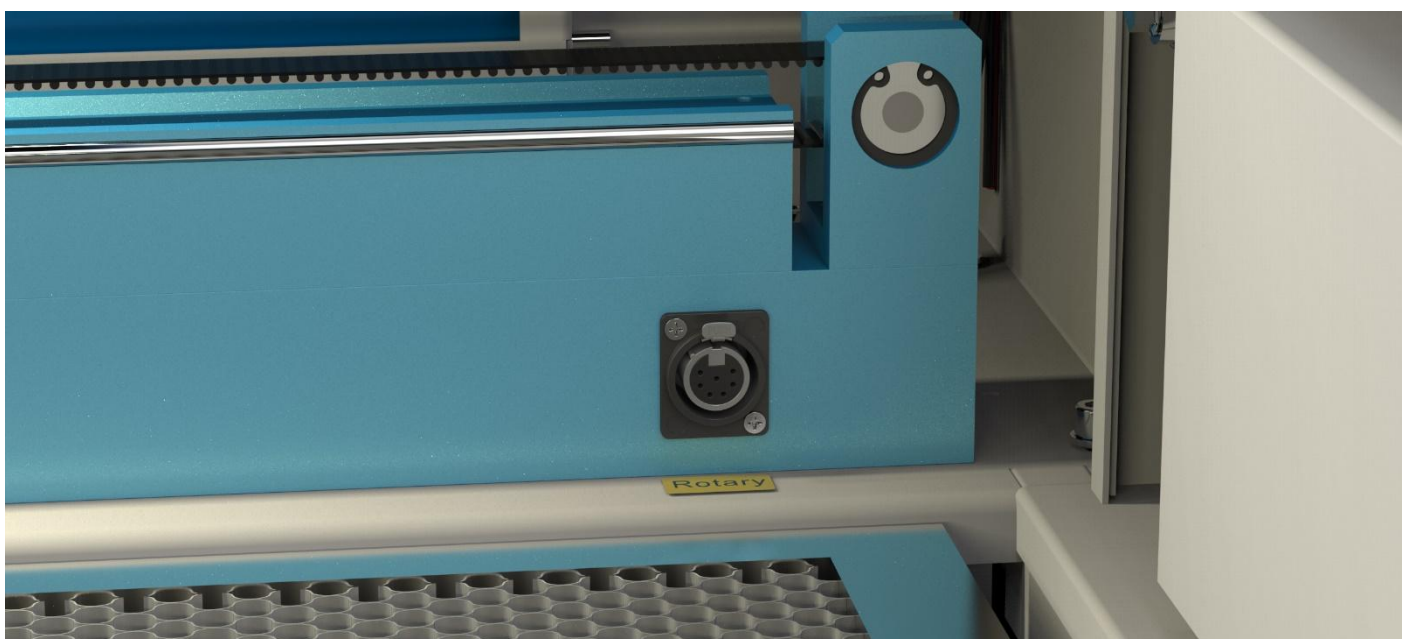

4. Before you mount the object into the rotary axis attachment, measure the diameter of the object at the position to be engraved with a sliding caliper or a similar tool. Write down this value. For example: 80mm.
5. Adjust and fix the slider to make the work piece fitting into the rotary axis attachment.
6. Set your focus manually, carefully and safely. It is not recommended to use the auto focus with a rotary axis attachment for the simple reason that you are not working with a flat object. Set your origin.
7. Generate a graphic with the help of the graphics software. The graphics size must be adjusted until less than the dimensions of the work piece.
8. Select "Output", and then input the diameter of the object and the circle pulse. How to set up the parameter for "enable rotate engrave", please click below link for the instruction.

[Rotary axis attachment has a wrong cylindrical engraving/cutting size](#)

9. Select "Download", click "Origin" and "Frame" on the LCD display, please make sure that the material is in the right location and enough space for working.
10. Finally press the "Start-Pause" button in the LCD display, to start the engraving or cutting process.

Also you can refer to the video of how the rotary axis works in our website:

[Rotary axis attachment has a wrong cylindrical engraving/cutting size](#)

4.14 For Laser Engraving

The engraving depth can easily be varied through the laser power or the speed. To increase the engraving depth, reduce the speed or increase the power setting. This way you increase the amount of energy per area unit. Engraving too deep, however, reduces the quality of the details. With coated materials the required power depends of the kind and thickness of the coating. With power set too high the individual lines become too thick and a sharp picture cannot be achieved. The resolution of the graphics should usually be at 500 dpi. The dpi setting (number of laser dots per inch) depends on the material. The lower this setting is, the lower the resolution of the engraved picture will be. This, however, reduces flaming and increases the energy of a pulse, which can improve the overall result (e.g. when engraving some sorts of plastic materials).

1. Plastics

Plastics for engraving are available in many different colors and thicknesses and with many different coatings and surfaces. The majority of available plastics can be well engraved and cut with the laser. Plastics with a micro-porous surface seem to give the best result, because less surface material needs to be removed. As most plastic materials have a low melting point, a low pip setting should be selected to reduce the danger of melting.

2. Acrylic

There are two different types of acrylic – cast and extruded. The cast acrylic becomes white or mat after engraving, the extruded acrylic remains clear. Use extruded acrylic for engravings that are filled with paint and cast acrylic for normal engravings. Cast acrylic can be best engraved without protection foil. It is better to engrave the entire surface with a low energy setting.

3. Engrave the rubber stamp

The various mixtures and densities of rubber plates cause a slightly varying engraving depth. The settings in the overview table give a good indication. Since engraving a standard rubber material requires a relatively high laser power, the laser power is principally set to 40% or more high and only the speed is varied. Due to their lower density, so-called micro porous rubber materials allow a significantly higher engraving speed. Test the rubber first, to find out the correct speed setting.

The RDWorksV8 software using the engraving function, you can choose “Ramp Effect” or common engraving, once you choose “Ramp Effect” and you will need to set a minimum power lower than Max Power, generally we set it to about 15%, and input a value with the Ramp Length what you want, but if you want to make it better, you may need to test different kinds of power and speed by yourself, then you can get the best result.

Engraving rubber produces a considerable amount of dust and terrible gas. Therefore a well-dimensioned exhaust system and its regular maintenance are very important.

Chapter 5. Maintenance

5.1 Cleaning the Laser Machine



Caution – use of controls or adjustments or performance of procedures other than those specified here in may result in hazardous laser radiation exposure.

Before starting cleaning and maintenance work always switch off the device and unplug the mains plug.

Always keep the system clean, as flammable parts in the working area or exhaust area rise the fire hazard.



You should check at least once a day, whether dust has accumulated in the engraving system. In case of soiling the machine must be cleaned. The cleaning interval strongly depends on the material that is being processed and the operating time of the device. Please bear in mind that only a clean machine guarantees optimal performance and reduces the service costs.

General Cleaning Notes:

1. Make sure, that the device is switched off and unplugged. Open the protective cover.
2. Move the working table into a position in which it is easiest for you to clean the surface with a window cleaning agent and paper towels.
3. Thoroughly remove all loose dirt particles and deposits in the interior of the machine.
4. Clean the cover of the laser tube.
5. You can clean the viewing window with a cotton cloth. Do not use paper towels as they could scratch the acrylic.

5.2 Cleaning the Optical Parts

The lens has a durable multi-coating and won't be damaged by correct and careful cleaning. You should inspect the focus lens and the mirrors and the beam combiner according the maintenance plan. If you discover a veil of haze or dirt, you must clean them.

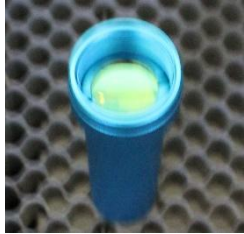

It is suggested to clean the mirrors/lens before work every day in order to run the machine at max efficiency.

Please turn off the power of laser machine before cleaning the optical parts.

Lens cleaning fluid and swabs are as follows:



1. Lens cleaning fluid and cotton swabs are in the tool box that came with the machine.
2. The lens must be cleaned carefully with a clean cotton swab to avoid scratching the surface of the lens.
3. Do not touch the lens with your hands after wiping.
4. Never use a cleaning swab twice.

Follow the instructions below for the cleaning of optical parts:

5.2.1 Cleaning the Focus Lens

1. Move the working table to a distance approx. 10 cm under the lens holder.
2. Move the working head into the center of the working surface.
3. Now you can unscrew the lens holder.
4. Remove the nozzle from the lens holder by carefully turning the lens holder.
5. Remove the coarse dust as good as possible by blowing air onto the lens surface.
6. Check the surface and if necessary clean the lens with the lens cleaning liquid and swabs.

- Put some lens cleaning liquid on one side of the lens. Leave the liquid to take effect for approximately one minute and then gently wipe it away with cleaning swabs soaked with lens cleaning liquid.
- Finally, dry this side of the lens with dry cleaning swabs and repeat the cleaning process on the other side of the lens. Never use a cleaning swabs twice. Dust accumulated in the cleaning swabs could scratch the lens surface.
- Examine the lens. If it is still soiled, repeat the cleaning process until the lens is clean.
- Carefully insert the lens holder and fix it.

How to take out the focus lens, please just as following the picture indicated:

1. Remove the laser head



2. Divide the laser head



3. Clean concave side of lens with swabs



4. Clean convex side of lens with swabs

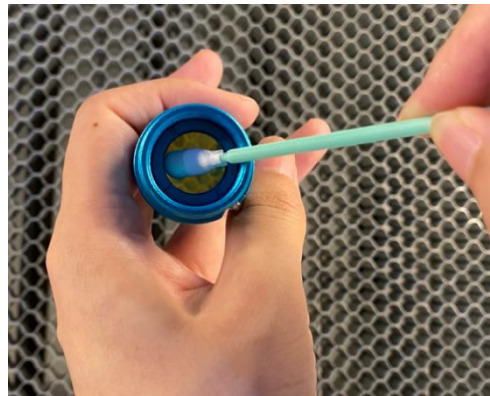

How to take out the lens, and please just as following the picture:

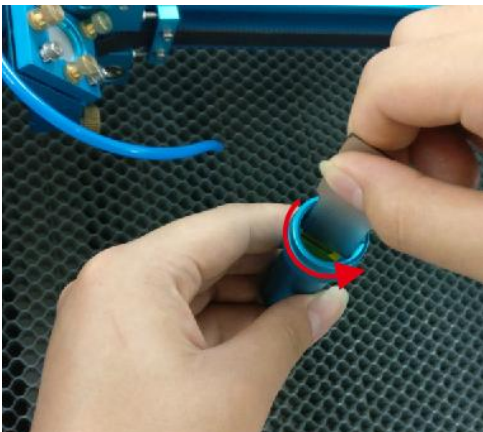

Note: please refer to the figure below for the installation direction of the focusing lens.

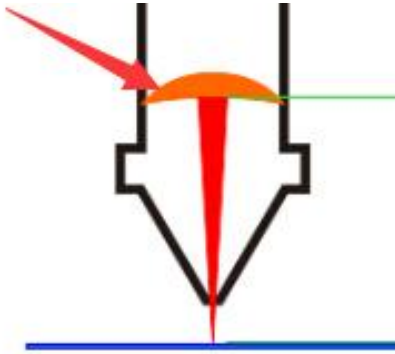

5.2.2 Cleaning the Mirrors

There are three mirrors in the operating area of the laser, which may have to be cleaned if they are soiled. To clean the reflector, follow the instructions below.

1. Remove the coarse dust as good as possible by blowing air onto the mirror surface.
2. Check the surface and if necessary clean the mirror with the lens cleaning liquid and swabs.
3. Put some lens cleaning liquid on one side of the mirror. Leave the liquid to take effect for approximately one minute and then gently wipe it away with cleaning swabs soaked with lens cleaning liquid.
4. Finally, dry this side of the mirror with dry cleaning swabs and repeat the cleaning process on the other side of the mirror. Never use a cleaning swabs twice. Dust accumulated in the cleaning swabs could scratch the mirror surface.
5. Examine the mirror. If it is still soiled, repeat the cleaning process until the lens is clean.

The Mirror#1

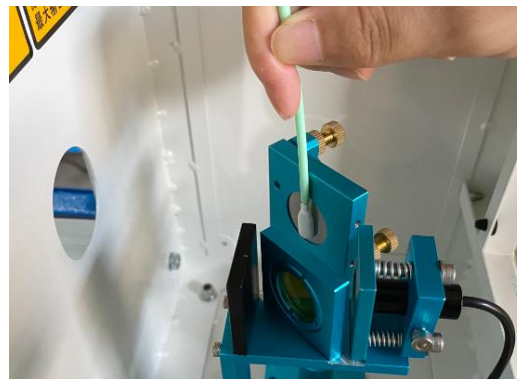

The 1st mirror is installed in the rear box of the laser tube, open it then view the right side.

The Mirror#2

Second mirror

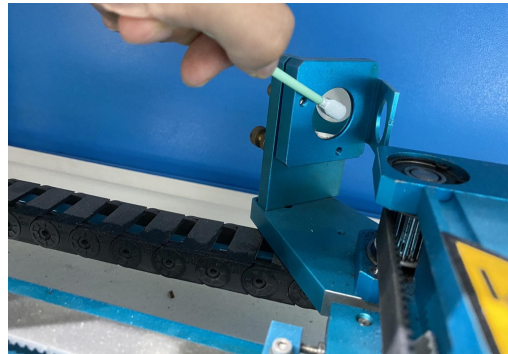
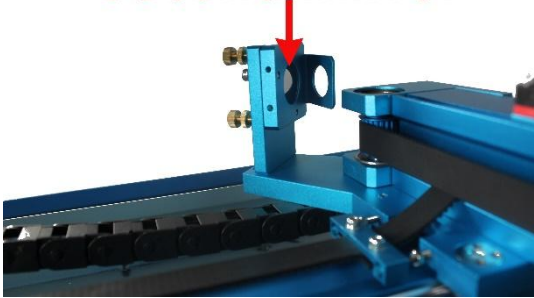

The 2nd mirror is installed on the left side of X rail.

The Mirror#3

Third mirror

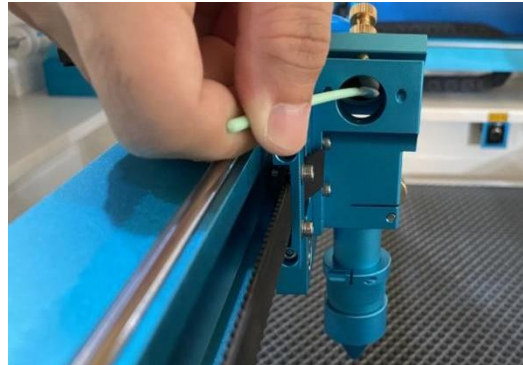

The 3rd mirror is installed on the top of the laser head.

How to take out the mirror#1 #2 and#3, and please just as following the picture indicated:

1. The mirror#1



2. The mirror#2

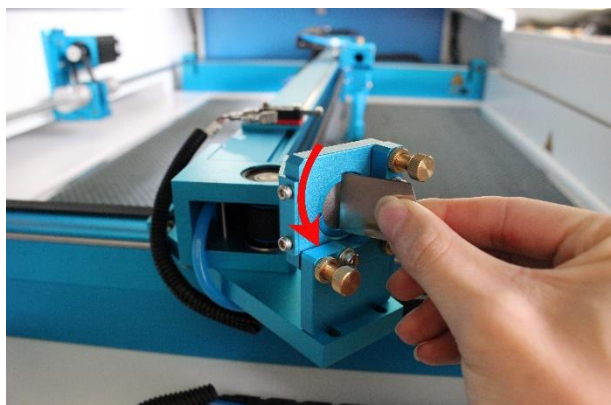

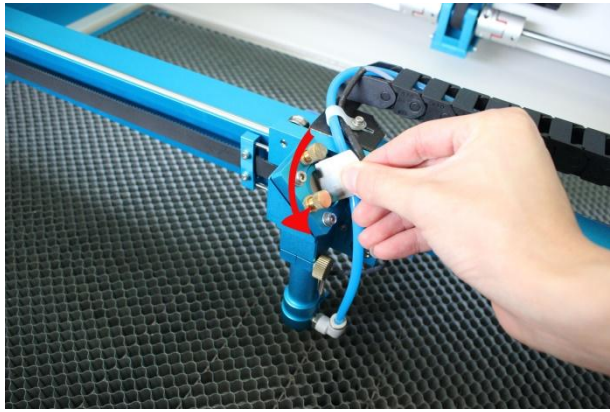

3. The mirror#3

5.2.3 Cleaning Laser Combiner

1. The laser combiner is installed on the left side of the first mirror.
2. Remove the coarse dust as good as possible by blowing air onto the lens surface.
3. Check the surface and if necessary clean the laser combiner with the lens cleaning liquid and swabs.
4. Put some lens cleaning liquid on one side of the swab. Leave the liquid to take effect for approximately one minute and then gently wipe it away with cleaning swabs soaked with lens cleaning liquid.
5. Finally, dry this side of the laser combiner with dry cleaning swabs and repeat the cleaning process on the other side of the lens. Never use a cleaning swab twice. Dust accumulated in the cleaning swabs could scratch the lens surface.
6. Examine the laser combiner. If it is still soiled, repeat the cleaning process until the lens is clean.

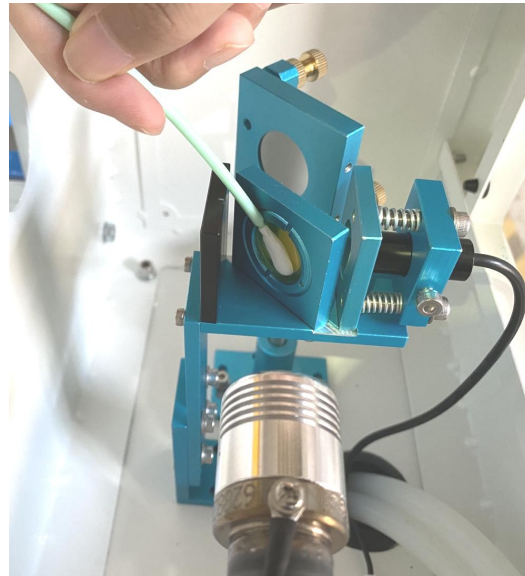
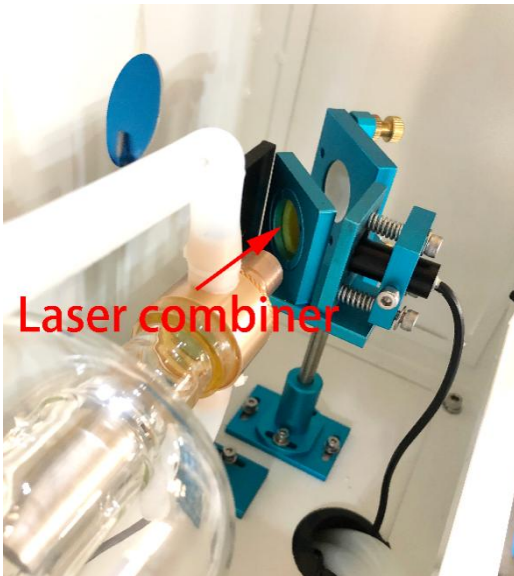

5.3 Maintain the X/Y/Z Rails

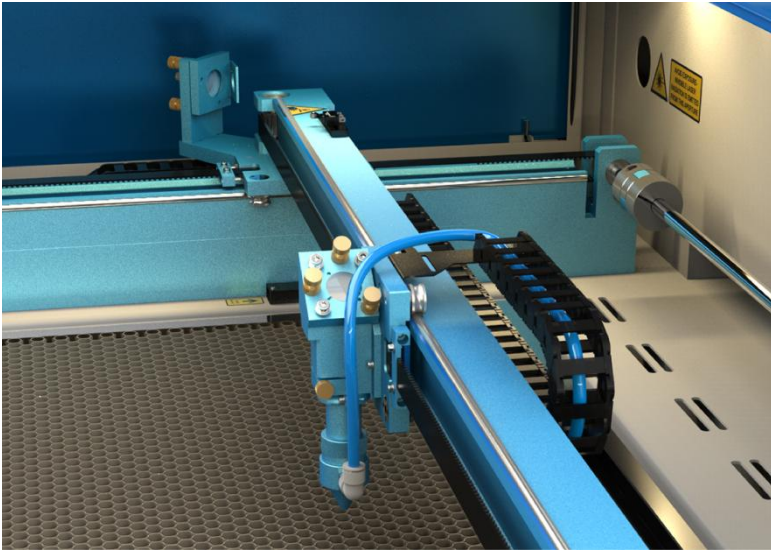

It is suggested to add lubricant oil (or Rust Preventative Grease) to the rails/screws at least every two weeks.

5.4 Check the Beam Path

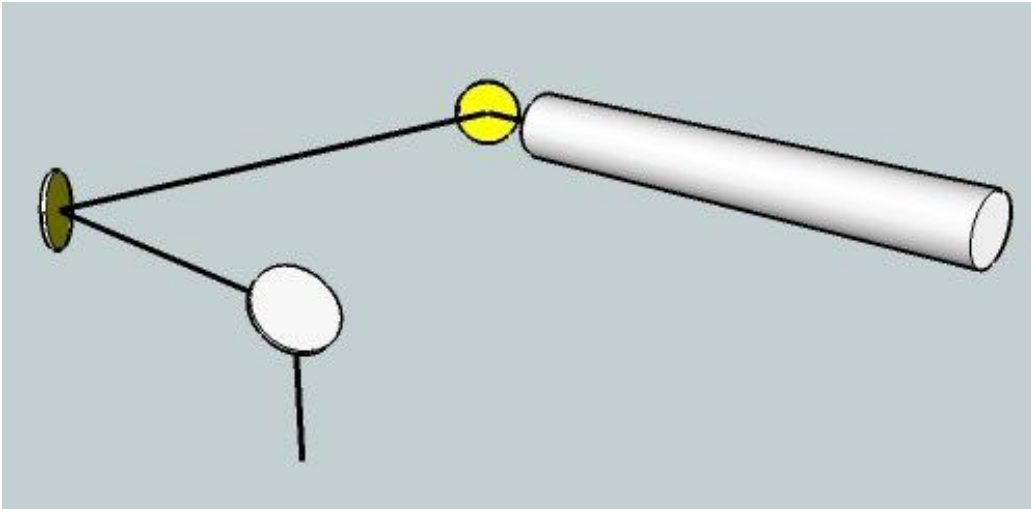

After being used for a long time, the beam path might be deflective. This will reduce the efficient of the laser beam or even cause no laser beam. At this moment, you will need to re-adjust the beam path again.

If you need to know that about adjust the laser beam path of the video on YouTube released by our company and please link to the URL:

[How to adjust the laser beam path](#)

5.5 Change Cooling Water for the Water Chiller



It is suggested to change the water every 3 months.

Make sure the laser tube is filled with water before starting the machine. It is advised to check the water level every month.

The quality and temperature of the cooling water affects the life time of the laser tube. You need to use pure distilled water and control the temperature below 35°C (95°F) .

5.6 Maintenance Plan

1. DAILY CHECK LIST

- ① Check Mirrors and lens for condensation and make sure it is clean after work
- ② Check exhaust grille to ensure there is no blockage for exhaust fan
- ③ Check coolant water level
- ④ Check air filter on compressor
- ⑤ Ensure cooling fans on sides are free from debris
- ⑥ The air blower must be checking and cleaning if required.

2. WEEKLY CHECK LIST

- ① Clean filters on water chiller
- ② Clean debris from under laser bed
- ③ Clean X & Y & Z axis rails and lubricate as required
- ④ Clean Acrylic/Tempered glass covers in lid
- ⑤ The beam combiner must be checking every weekly, and cleaning if required.

THE END